

FUJIFILM

DIGITAL CAMERA

X-H2

FF210003

Owner's Manual

Introduction

Thank you for your purchase of this product. Be sure that you have read this manual and understood its contents before using the camera. Keep the manual where it will be read by all who use the product.

For the Latest Information

The latest versions of the manuals are available from:

<https://fujifilm-dsc.com/en/manual/>



The website can be accessed not only from your computer but also from smartphones and tablets. It also contains information on the software license.



For information on firmware updates, visit:

<https://fujifilm-x.com/support/download/firmware/cameras/>



Chapter Index

Menu List	iv
1 Before You Begin	1
2 First Steps	37
3 Basic Photography and Playback	55
4 Movie Recording and Playback	63
5 Taking Photographs	71
6 The Shooting Menus	127
7 Playback and the Playback Menu	215
8 Network/USB Setting Menus	243
9 The Setup Menus	245
10 Shortcuts	287
11 Peripherals and Optional Accessories	309
12 Technical Notes	339

Menu List

Camera menu options are listed below.

Shooting Menu

Adjust settings when shooting photos or movies.













 See page 127 for details.





Photo Menu































 Items marked with both  and  icons are available in both the still photography and movie shooting menus. Changes to these items in either menu also apply to the item in the remaining menu.



















 IMAGE QUALITY SETTING		 IMAGE QUALITY SETTING	
IMAGE SIZE	:128	HIGH ISO NR	:142
IMAGE QUALITY	:129	CLARITY	:142
RAW RECORDING	:130	LONG EXPOSURE NR	:142
SELECT JPEG/HEIF	:131	LENS MODULATION OPTIMIZER	:143
FILM SIMULATION	:132	COLOR SPACE	:143
MONOCHROMATIC COLOR	:134	PIXEL MAPPING	:143
GRAIN EFFECT	:134	 EDIT/SAVE CUSTOM SETTING	:144
COLOR CHROME EFFECT	:135	AUTO UPDATE CUSTOM SETTING	:144
COLOR CHROME FX BLUE	:135	  CUSTOM MODE SETTING	:144
SMOOTH SKIN EFFECT	:135	  MOUNT ADAPTOR SETTING	:145
WHITE BALANCE	:136		
DYNAMIC RANGE	:140		
D RANGE PRIORITY	:140		
TONE CURVE	:141		
COLOR	:141		
SHARPNESS	:141		

AF/MF SETTING			SHOOTING SETTING			
1/3	FOCUS AREA	148	1/3	FILTER SETTING	166	
	FOCUS MODE	148		SPORTS FINDER MODE	166	
	AF MODE	148		PRE-SHOT ES	167	
	AF-C CUSTOM SETTINGS	149		SELF-TIMER	168	
	STORE AF MODE BY ORIENTATION	153		SAVE SELF-TIMER SETTING	169	
	AF POINT DISPLAY	153		SELF-TIMER LAMP	169	
2/3	NUMBER OF FOCUS POINTS	153	INTERVAL TIMER SHOOTING	170		
	PRE-AF	154	INTERVAL TIMER SHOOTING EXPOSURE SMOOTHING	171		
	AF ILLUMINATOR	154	AE BKT SETTING	172		
	FACE/EYE DETECTION SETTING	155	FILM SIMULATION BKT	172		
	SUBJECT DETECTION SETTING	157	FOCUS BKT SETTING	172		
	AF+MF	159	2/3	PHOTOMETRY	172	
	MF ASSIST	160		SHUTTER TYPE	173	
	FOCUS CHECK	160	FLICKER REDUCTION	174		
	INTERLOCK SPOT AE & FOCUS AREA	161	FLICKERLESS S.S. SETTING	174		
	INSTANT AF SETTING	161	IS MODE	175		
3/3	DEPTH-OF-FIELD SCALE	161	ISO	175		
	RELEASE/FOCUS PRIORITY	162	DIGITAL TELE-CONV.	175		
	AF RANGE LIMITER	163	3/3	COOLING FAN SETTING	176	
	TOUCH SCREEN MODE	164		WIRELESS COMMUNICATION	176	
FLASH SETTING				FLASH SETTING		
FLASH FUNCTION SETTING			FLASH FUNCTION SETTING			177
RED EYE REMOVAL			RED EYE REMOVAL			177
TTL-LOCK MODE			TTL-LOCK MODE			178
LED LIGHT SETTING			LED LIGHT SETTING			178
COMMANDER SETTING			COMMANDER SETTING			179
CH SETTING			CH SETTING			179
MOVIE SETTING				MOVIE SETTING		
MOVIE MODE			MOVIE MODE			180
HIGH SPEED REC			HIGH SPEED REC			180
MEDIA REC SETTING			MEDIA REC SETTING			180
IS MODE			IS MODE			180
IS MODE BOOST			IS MODE BOOST			180
AUDIO SETTING			AUDIO SETTING			181

Movie Menus

  Items marked with both  and  icons are available in both the still photography and movie shooting menus. Changes to these items in either menu also apply to the item in the remaining menu.



 MOVIE SETTING		 IMAGE QUALITY SETTING	
MOVIE SETTING LIST	184	 FILM SIMULATION	199
SHOOTING MODE	184	 MONOCHROMATIC COLOR	199
MOVIE MODE	185	 WHITE BALANCE	200
HIGH SPEED REC	186	 DYNAMIC RANGE	200
$\frac{1}{3}$ MEDIA REC SETTING	187	$\frac{1}{2}$  TONE CURVE	200
HDMI OUTPUT SETTING	191	 COLOR	200
FIX MOVIE CROP MAGNIFICATION	192	 SHARPNESS	201
DIGITAL ZOOM	192	 HIGH ISO NR	201
F-Log/HLG RECORDING	193	INTERFRAME NR	201
DATA LEVEL SETTING	194	$\frac{2}{3}$  PERIPHERAL LIGHT CORRECTION	202
 PHOTOMETRY	194	  MOUNT ADAPTOR SETTING	202
$\frac{2}{3}$  FLICKERLESS S.S. SETTING	194		
 IS MODE	195		
 IS MODE BOOST	195		
 ISO	196		
ZEBRA SETTING	196		
ZEBRA LEVEL	196		
MOVIE OPTIMIZED CONTROL  	197		
TALLY LIGHT	197		
$\frac{3}{3}$   COOLING FAN SETTING	198		
 EDIT/SAVE CUSTOM SETTING	198		
 AUTO UPDATE CUSTOM SETTING	198		
  CUSTOM MODE SETTING	198		
  WIRELESS COMMUNICATION	198		

AF/MF SETTING			AUDIO SETTING		
1/2	 FOCUS AREA	203	INTERNAL MIC LEVEL ADJUSTMENT	209	
	 FOCUS MODE	203	EXTERNAL MIC LEVEL ADJUSTMENT	209	
	 AF MODE	204	MIC JACK SETTING	210	
	 AF-C CUSTOM SETTING	204	MIC LEVEL LIMITER	210	
	 AF ILLUMINATOR	205	WIND FILTER	210	
	 FACE/EYE DETECTION SETTING	205	LOW CUT FILTER	210	
	 SUBJECT DETECTION SETTING	205	HEADPHONES VOLUME	210	
	 AF+MF	205	XLR MIC ADAPTER SETTING	211	
	 MF ASSIST	206	TC TIME CODE SETTING		
	 FOCUS CHECK	206	TIME CODE DISPLAY	212	
2/2	 FOCUS CHECK	206	START TIME SETTING	212	
	 INSTANT AF SETTING	206	COUNT UP SETTING	213	
	 DEPTH-OF-FIELD SCALE	206	DROP FRAME	213	
	 AF RANGE LIMITER	206	HDMI TIME CODE OUTPUT	214	
	 TOUCH SCREEN MODE	207			
FOCUS CHECK LOCK	208				

The Playback Menu

Adjust playback settings.













 See page 221 for details.

▶ PLAY BACK MENU 		▶ PLAY BACK MENU 		
1/3	SWITCH SLOT	221	IMAGE ROTATE	230
	RAW CONVERSION	222	VOICE MEMO SETTING	231
	HEIF TO JPEG/TIFF CONVERSION	224	RATING	232
	ERASE	225	2/3 COPY	233
	SIMULTANEOUS DELETE	227	TRANSFER IMAGE TO SMARTPHONE	234
	CROP	227	 WIRELESS COMMUNICATION	236
	RESIZE	228	SLIDE SHOW	236
PROTECT	229	PHOTOBOOK ASSIST	237	
			PRINT ORDER (DPOF)	239
		3/3 instax PRINTER PRINT	240	
		DISP ASPECT	241	

Setup Menu

Adjust basic camera settings.

 See page 245 for details.

 USER SETTING 		 SCREEN SETTING 		
	FORMAT		VIEW MODE SETTING	
	 AREA SETTING		EVF BRIGHTNESS	
	DATE/TIME		EVF COLOR	
1/2	TIME DIFFERENCE	1/4	EVF COLOR ADJUSTMENT	
	 言語/LANG.		LCD BRIGHTNESS	
	 MY MENU SETTING		LCD COLOR	
	 MY MENU SETTING		LCD COLOR ADJUSTMENT	
	SENSOR CLEANING		IMAGE DISP.	
	BATTERY AGE		AUTOROTATE DISPLAYS	
2 1/2	RESET		PREVIEW EXP./WB IN MANUAL MODE	
	REGULATORY		NATURAL LIVE VIEW	
 SOUND SETTING 		2/4	F-Log VIEW ASSIST	
1 1/2	AF BEEP VOL.		ELECTRONIC LEVEL SETTING	
	SELF-TIMER BEEP VOL.		FRAMING GUIDELINE	
	OPERATION VOL.		AUTOROTATE PB	
	MS EF ELECTRONIC SHUTTER VOLUME		FOCUS SCALE UNITS	
	MS EF ELECTRONIC SHUTTER SOUND		APERTURE UNIT FOR CINEMA LENS	
	ES ELECTRONIC SHUTTER VOLUME		DUAL DISPLAY SETTING	
	ES ELECTRONIC SHUTTER SOUND		DISP. CUSTOM SETTING	
2 1/2	PLAYBACK VOLUME		3/4	LARGE INDICATORS MODE(EVF)
	4ch AUDIO PLAYBACK			LARGE INDICATORS MODE(LCD)
			LARGE INDICATORS DISP. SETTING	
			INFORMATION CONTRAST ADJ.	
			LOCATION INFO	
			SUB MONITOR SETTING	
		4/4	SUB MONITOR BACKGROUND COLOR	
			 Q MENU BACKGROUND	
			 Q MENU BACKGROUND	

1/3	BUTTON/DIAL SETTING		POWER MANAGEMENT		
	FOCUS LEVER SETTING	270	AUTO POWER OFF	281	
	EDIT/SAVE QUICK MENU	271	PERFORMANCE	281	
	EDIT/SAVE QUICK MENU	271	EVF/LCD BOOST SETTING	282	
	FUNCTION (Fn) SETTING	271	AUTO POWER OFF TEMP.	282	
	POWER ZOOM LENS FUNCTION (Fn) SETTING	271	SAVE DATA SETTING		
	SELECTOR BUTTON SETTING	271	FRAME NO.	283	
	COMMAND DIAL SETTING	272	EDIT FILE NAME	284	
	S.S OPERATION	272	CARD SLOT SETTING	284	
	COMMAND DIAL DIRECTION	272	SELECT SLOT (SEQUENTIAL)	284	
2/3	SHUTTER AF	273	SELECT FOLDER	285	
	SHUTTER AE	273	COPYRIGHT INFO	285	
	SHOOT WITHOUT LENS	273	DEFAULT CAPTION	286	
	SHOOT WITHOUT CARD	274	GEOTAGGING	286	
	LENS ZOOM/FOCUS SETTING	274			
	AE/AF-LOCK MODE	276			
	AWB-LOCK MODE	276			
	ISO BUTTON SETTING	277			
	3/3	TOUCH SCREEN SETTING	278		
		LOCK	280		

The Network/USB Settings Menu

Adjust camera network and USB settings. For more information, visit:

https://fujifilm-dsc.com/en/manual/x-h2_connection/



Table of Contents

Introduction	ii
For the Latest Information.....	ii
Menu List	iv
Shooting Menus.....	iv
The Playback Menu.....	viii
Setup Menus.....	ix
The Network/USB Settings Menu.....	x
Supplied Accessories	xxiii
About This Manual	xxiv
Symbols and Conventions.....	xxiv
Terminology.....	xxiv

1 Before You Begin **1**

Parts of the Camera	2
The Serial Number Plate.....	6
The Memory Card Slot Cover (Detachable).....	6
The Focus Stick (Focus Lever).....	7
The Selector.....	7
The WB Button.....	7
The Mode Dial.....	8
The DRIVE Button.....	9
The Command Dials.....	10
The Indicator Lamp.....	11
The LCD Monitor.....	12
The Eye Cup.....	13
Focusing the Viewfinder.....	13
Camera Displays	14
The Electronic Viewfinder.....	14
The LCD Monitor.....	16
Choosing a Display Mode.....	18
Adjusting Display Brightness.....	20
Display Rotation.....	20
The DISP/BACK Button.....	21
The Dual Display.....	22

Customizing the Standard Display.....	23
Virtual Horizon.....	25
The Secondary LCD Monitor.....	26
Using the Menu	28
The Menu.....	28
Selecting a Menu Tab.....	30
Touch Screen Mode.....	31
Shooting Touch Controls	31
Playback Touch Controls.....	36

2 First Steps 37

Attaching the Strap.....	38
Attaching a Lens.....	39
Inserting the Battery.....	40
Inserting Memory Cards.....	42
Using Two Cards.....	44
Compatible Memory Cards	45
Charging the Battery	46
Turning the Camera On and Off	50
Checking the Battery Level.....	51
Basic Setup	52
Choosing a Different Language.....	54
Changing the Time and Date	54











3 Basic Photography and Playback 55













Taking Photographs (Mode P).....	56
Viewing Pictures	59
HDMI Output.....	60
Deleting Pictures.....	62

























4 Movie Recording and Playback 63

















Recording Movies	64
Recording Movies.....	64
Adjusting Movie Settings.....	68
Viewing Movies.....	69

5 Taking Photographs	71
P, S, A, and M Modes.....	72
Mode P: Program AE	72
Mode S: Shutter-Priority AE.....	74
Mode A: Aperture-Priority AE	76
Mode M: Manual Exposure	78
FILTER.....	82
Custom Modes	83
Autofocus.....	91
Focus Mode.....	92
Autofocus Options (AF Mode).....	94
Focus-Point Selection.....	96
Manual Focus.....	100
Checking Focus.....	102
Sensitivity.....	105
AUTO.....	106
Metering.....	107
Exposure Compensation	108
Focus/Exposure Lock	109
Other Controls	110
Continuous Shooting (Burst Mode).....	111
Bracketing.....	113
ISO ISO BKT.....	114
WB WHITE BALANCE BKT.....	114
BKT Bracketing.....	115
HDR	118
Panoramas	120
Multiple Exposures.....	123
Pixel-Shift Multi-Shot.....	125
6 The Shooting Menus	127
IMAGE QUALITY SETTING (Still Photography)	128
IMAGE SIZE.....	128
IMAGE QUALITY	129
RAW RECORDING	130
SELECT JPEG/HEIF.....	131
FILM SIMULATION.....	132

MONOCHROMATIC COLOR.....	134
GRAIN EFFECT	134
COLOR CHROME EFFECT.....	135
COLOR CHROME FX BLUE.....	135
SMOOTH SKIN EFFECT	135
WHITE BALANCE.....	136
DYNAMIC RANGE.....	140
D RANGE PRIORITY.....	140
TONE CURVE.....	141
COLOR.....	141
SHARPNESS.....	141
HIGH ISO NR.....	142
CLARITY.....	142
LONG EXPOSURE NR.....	142
LENS MODULATION OPTIMIZER	143
COLOR SPACE	143
PIXEL MAPPING	143
 EDIT/SAVE CUSTOM SETTING	144
AUTO UPDATE CUSTOM SETTING.....	144
  CUSTOM MODE SETTING.....	144
  MOUNT ADAPTOR SETTING.....	145
AF/MF SETTING (Still Photography)	148
FOCUS AREA	148
FOCUS MODE.....	148
AF MODE.....	148
AF-C CUSTOM SETTINGS.....	149
STORE AF MODE BY ORIENTATION.....	153
AF POINT DISPLAY  	153
NUMBER OF FOCUS POINTS.....	153
PRE-AF.....	154
  AF ILLUMINATOR	154
 FACE/EYE DETECTION SETTING	155
SUBJECT DETECTION SETTING	157
AF+MF	159
MF ASSIST	160
FOCUS CHECK.....	160
INTERLOCK SPOT AE & FOCUS AREA.....	161

 	INSTANT AF SETTING	161
 	DEPTH-OF-FIELD SCALE.....	161
	RELEASE/FOCUS PRIORITY	162
 	AF RANGE LIMITER.....	163
	TOUCH SCREEN MODE.....	164
SHOOTING SETTING (Still Photography).....		166
	FILTER SETTING.....	166
	SPORTS FINDER MODE	166
	PRE-SHOT  	167
	SELF-TIMER.....	168
	SAVE SELF-TIMER SETTING.....	169
	SELF-TIMER LAMP.....	169
	INTERVAL TIMER SHOOTING.....	170
	INTERVAL TIMER SHOOTING EXPOSURE SMOOTHING.....	171
	AE BKT SETTING	172
	FILM SIMULATION BKT	172
	FOCUS BKT SETTING	172
	PHOTOMETRY.....	172
	SHUTTER TYPE.....	173
	FLICKER REDUCTION.....	174
	FLICKERLESS S.S. SETTING.....	174
	IS MODE.....	175
	ISO	175
	DIGITAL TELE-CONV.	175
 	COOLING FAN SETTING.....	176
 	WIRELESS COMMUNICATION.....	176
FLASH SETTING (Still Photography)		177
	FLASH FUNCTION SETTING	177
	RED EYE REMOVAL.....	177
	TTL-LOCK MODE	178
	LED LIGHT SETTING	178
	COMMANDER SETTING.....	179
	CH SETTING	179
MOVIE SETTING (Still Photography)		180
	MOVIE MODE.....	180
	HIGH SPEED REC.....	180
	MEDIA REC SETTING.....	180

 IS MODE.....	180
 IS MODE BOOST.....	180
AUDIO SETTING.....	181
MOVIE SETTING (Movie Recording).....	184
MOVIE SETTING LIST.....	184
SHOOTING MODE.....	184
MOVIE MODE.....	185
HIGH SPEED REC.....	186
MEDIA REC SETTING.....	187
HDMI OUTPUT SETTING.....	191
FIX MOVIE CROP MAGNIFICATION.....	192
DIGITAL ZOOM.....	192
F-Log/HLG RECORDING.....	193
DATA LEVEL SETTING.....	194
 PHOTOMETRY.....	194
 FLICKERLESS S.S. SETTING.....	194
 IS MODE.....	195
 IS MODE BOOST.....	195
 ISO.....	196
ZEBRA SETTING.....	196
ZEBRA LEVEL.....	196
MOVIE OPTIMIZED CONTROL 	197
TALLY LIGHT.....	197
  COOLING FAN SETTING.....	198
 EDIT/SAVE CUSTOM SETTING.....	198
 AUTO UPDATE CUSTOM SETTING.....	198
  CUSTOM MODE SETTING.....	198
  WIRELESS COMMUNICATION.....	198
IMAGE QUALITY SETTING (Movie Recording).....	199
 FILM SIMULATION.....	199
 MONOCHROMATIC COLOR.....	199
 WHITE BALANCE.....	200
 DYNAMIC RANGE.....	200
 TONE CURVE.....	200
 COLOR.....	200
 SHARPNESS.....	201
 HIGH ISO NR.....	201

INTERFRAME NR.....	201
 PERIPHERAL LIGHT CORRECTION	202
 MOUNT ADAPTOR SETTING	202
AF/MF SETTING (Movie Recording).....	203
 FOCUS AREA	203
 FOCUS MODE.....	203
 AF MODE.....	204
 AF-C CUSTOM SETTING	204
 AF ILLUMINATOR	205
 FACE/EYE DETECTION SETTING	205
 SUBJECT DETECTION SETTING	205
 AF+MF	205
 MF ASSIST	206
 FOCUS CHECK.....	206
 INSTANT AF SETTING	206
 DEPTH-OF-FIELD SCALE.....	206
 AF RANGE LIMITER.....	206
 TOUCH SCREEN MODE.....	207
FOCUS CHECK LOCK	208
AUDIO SETTING (Movie Recording).....	209
INTERNAL MIC LEVEL ADJUSTMENT.....	209
EXTERNAL MIC LEVEL ADJUSTMENT.....	209
MIC JACK SETTING.....	210
MIC LEVEL LIMITER	210
WIND FILTER.....	210
LOW CUT FILTER.....	210
HEADPHONES VOLUME	210
XLR MIC ADAPTER SETTING.....	211
TIME CODE SETTING (Movie Recording).....	212
TIME CODE DISPLAY	212
START TIME SETTING	212
COUNT UP SETTING.....	213
DROP FRAME	213
HDMI TIME CODE OUTPUT.....	214

7 Playback and the Playback Menu 215



The Playback Display	216
The DISP/BACK Button.....	217
Viewing Pictures	219
Playback Zoom.....	220
Multi-Frame Playback.....	220
The Playback Menu	221
SWITCH SLOT	221
RAW CONVERSION	222
HEIF TO JPEG/TIFF CONVERSION.....	224
ERASE.....	225
SIMULTANEOUS DELETE.....	227
CROP	227
RESIZE.....	228
PROTECT.....	229
IMAGE ROTATE	230
VOICE MEMO SETTING.....	231
RATING.....	232
COPY	233
TRANSFER IMAGE TO SMARTPHONE.....	234
📷📶 WIRELESS COMMUNICATION.....	236
SLIDE SHOW	236
PHOTOBOOK ASSIST	237
PRINT ORDER (DPOF).....	239
instax PRINTER PRINT	240
DISP ASPECT.....	241







8 Network/USB Setting Menus 243

Network/USB Setting Menu	244
--------------------------------	-----

9 The Setup Menus 245

USER SETTING	246
FORMAT.....	246
🏠 AREA SETTING.....	247
DATE/TIME.....	247
TIME DIFFERENCE.....	248

 言語/LANG	249
 MY MENU SETTING.....	249
 MY MENU SETTING.....	249
SENSOR CLEANING	250
BATTERY AGE	250
RESET	251
REGULATORY.....	251
SOUND SETTING.....	252
AF BEEP VOL.	252
SELF-TIMER BEEP VOL.	252
OPERATION VOL.	253
MSEF ELECTRONIC SHUTTER VOLUME	253
MSEF ELECTRONIC SHUTTER SOUND	253
ES ELECTRONIC SHUTTER VOLUME	254
ES ELECTRONIC SHUTTER SOUND	254
PLAYBACK VOLUME	254
4ch AUDIO PLAYBACK.....	255
SCREEN SETTING	256
VIEW MODE SETTING.....	256
EVF BRIGHTNESS.....	256
EVF COLOR	256
EVF COLOR ADJUSTMENT.....	257
LCD BRIGHTNESS.....	258
LCD COLOR	258
LCD COLOR ADJUSTMENT.....	258
IMAGE DISP.....	259
AUTOROTATE DISPLAYS.....	259
PREVIEW EXP/WB IN MANUAL MODE.....	260
NATURAL LIVE VIEW.....	260
F-Log VIEW ASSIST.....	261
ELECTRONIC LEVEL SETTING	261
FRAMING GUIDELINE.....	262
AUTOROTATE PB.....	263
FOCUS SCALE UNITS	263
APERTURE UNIT FOR CINEMA LENS.....	263
DUAL DISPLAY SETTING	264

DISP. CUSTOM SETTING.....	264
LARGE INDICATORS MODE(EVF)	265
LARGE INDICATORS MODE(LCD)	265
LARGE INDICATORS DISP. SETTING.....	266
INFORMATION CONTRAST ADJ.....	266
LOCATION INFO.....	267
SUB MONITOR SETTING.....	267
SUB MONITOR BACKGROUND COLOR.....	268
 Q MENU BACKGROUND	269
 Q MENU BACKGROUND	269
BUTTON/DIAL SETTING.....	270
FOCUS LEVER SETTING	270
 EDIT/SAVE QUICK MENU	271
 EDIT/SAVE QUICK MENU	271
FUNCTION (Fn) SETTING.....	271
POWER ZOOM LENS FUNCTION (Fn) SETTING.....	271
SELECTOR BUTTON SETTING	271
COMMAND DIAL SETTING	272
 S.S OPERATION	272
COMMAND DIAL DIRECTION.....	272
SHUTTER AF	273
SHUTTER AE.....	273
SHOOT WITHOUT LENS	273
SHOOT WITHOUT CARD.....	274
LENS ZOOM/FOCUS SETTING	274
AE/AF-LOCK MODE.....	276
AWB-LOCK MODE	276
 ISO BUTTON SETTING.....	277
TOUCH SCREEN SETTING	278
LOCK.....	280
POWER MANAGEMENT	281
AUTO POWER OFF	281
PERFORMANCE.....	281
EVF/LCD BOOST SETTING	282
AUTO POWER OFF TEMP.....	282
SAVE DATA SETTING.....	283
FRAME NO.	283

EDIT FILE NAME.....	284
📷 CARD SLOT SETTING.....	284
SELECT SLOT(📷 SEQUENTIAL).....	284
SELECT FOLDER.....	285
COPYRIGHT INFO.....	285
DEFAULT CAPTION.....	286
GEOTAGGING.....	286

10 Shortcuts 287

Shortcut Options.....	288
MY MENU	289
MY MENU SETTING	289
The Quick Menu	291
The Quick Menu Display.....	291
Viewing and Changing Settings.....	293
Editing the Quick Menu.....	294
Function Controls.....	297
The Function Buttons.....	297
Touch-Function Gestures.....	303
Lens Function Buttons.....	306

11 Peripherals and Optional Accessories 309

Lenses.....	310
Lens Parts.....	310
Lens Care.....	311
Removing Lens Caps.....	311
Attaching Lens Hoods.....	312
Lenses with Aperture Rings.....	313
Lenses with No Aperture Rings.....	314
Lenses with O.I.S. Switches.....	314
Manual Focus Lenses.....	315
Power Zoom Lenses.....	316

External Flash Units	317
Flash Settings.....	318
EF-X8	319
SYNC TERMINAL	321
SHOE MOUNT FLASH.....	322
COMMANDER(OPTICAL)	325
Vertical Battery Grips	329
Attaching the Vertical Battery Grip	330
Inserting and Removing Batteries	331
Charging the Batteries	333
File Transmitters	334
Attaching the File Transmitter.....	335
Inserting and Removing Batteries	335
Charging the Batteries	335
Cooling Fans	336
Attaching a Cooling Fan	336
Using the Fan.....	338

12 Technical Notes **339**

Accessories from Fujifilm	340
Software for Use with Your Camera	343
Smartphone Apps	343
RAW FILE CONVERTER EX powered by SILKYPIX.....	343
Capture One Express for Fujifilm	344
Capture One for Fujifilm	344
FUJIFILM Tether Shooting Plug-in (Exclusively for Lightroom).....	344
FUJIFILM X Acquire	344
FUJIFILM X RAW STUDIO	345
FUJIFILM Pixel Shift Combiner	345
For Your Safety	346
Product Care	357
Cleaning the Image Sensor	358
Firmware Updates	359
Checking the Firmware Version	359
Troubleshooting	360
Warning Messages and Displays	367
Memory Card Capacity	371
Specifications	372

Supplied Accessories

The following are included with the camera:

- NP-W235 rechargeable battery



For reasons of safety, the battery is not charged at shipment. The camera will not function if the battery is not charged; be sure to charge the battery before use (📖 46).

- AC-5VJ AC power adapter
- Plug adapter
- USB cable (approx. 0.6 m/2 ft.)
- Body cap (comes attached to camera)
- Shoulder strap
- Cable protector
- Hot shoe cover (comes attached to hot shoe)
- Sync terminal cap (comes attached to camera)
- File transmitter/vertical battery grip connector cover (comes attached to camera)
- Cooling fan connector cover (comes attached to camera)
- *Basic Manual*





- If you purchased a lens kit, check that a lens is included.
- The plug adapter supplied varies with the country or region.
- For information on compatible computer software, see “Software for Use with Your Camera” (📖 343).

About This Manual

This manual contains instructions for your FUJIFILM X-H2 digital camera. Be sure you have read and understood its contents before proceeding.

Symbols and Conventions

The following symbols are used in this manual:

-  Information that should be read to prevent damage to the product.
-  Additional information that may be helpful when using the product.
-  Pages on which related information may be found.

Menus and other text in the displays are shown in **bold**. Illustrations are for explanatory purposes only; drawings may be simplified, while photographs are not necessarily taken with the model of camera described in this manual.

Terminology

The optional SD, SDHC, SDXC, and Type B CFexpress memory cards the camera uses to store pictures are referred to as “memory cards”. The electronic viewfinder may be referred to as the “EVF” and the LCD monitor as the “LCD”. Smartphones and tablets are referred to as “smartphones”.

Before You Begin



Parts of the Camera

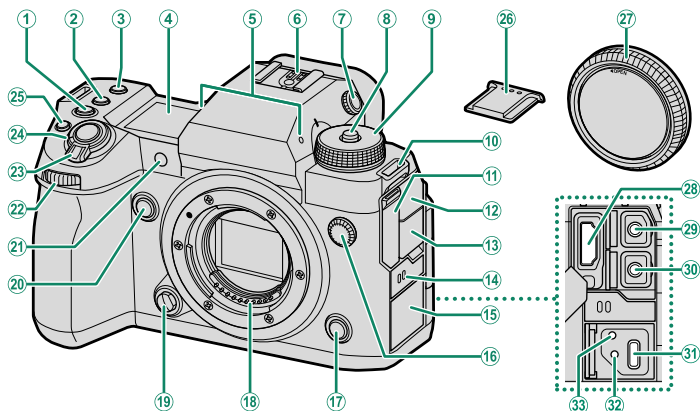

① ISO button.....	105, 297	①⑨ Lens release button.....	39
② WB button.....	7, 297	②⑩ Fn2 button.....	297
③ Fn1 button.....	297	③⑪ AF-assist illuminator.....	154
④ Secondary LCD monitor.....	26	Self-timer lamp.....	168
⑤ Microphone.....	64	Tally light.....	197
⑥ Hot shoe.....	318	②② Front command dial.....	10, 272
⑦ Diopter adjustment control.....	13	③③ ON/OFF switch.....	50
⑧ Dial lock release.....	56, 64	④④ Shutter button.....	58
⑨ Mode dial.....	8	⑤⑤ (movie recording) button.....	64, 297
⑩ Strap eyelet.....	38	⑥⑥ Hot shoe cover.....	318
⑪ HDMI connector cover		⑦⑦ Body cap.....	39
⑫ Microphone jack cover		⑧⑧ HDMI connector (Type A).....	60
⑬ Headphone jack cover		⑨⑨ Microphone jack (ø3.5mm).....	67
⑭ Speaker.....	69, 254	⑩⑩ Headphone jack (ø3.5mm).....	210
⑮ USB connector cover		⑪⑪ USB connector (Type-C).....	46
⑯ Sync terminal.....	321	⑫⑫ Hole to screw USB cable	
⑰ Fn3 button.....	297	⑬⑬ Hole to screw cable protector	
⑱ Lens signal contacts			

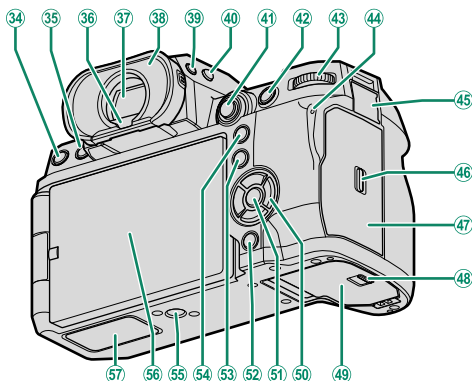

- | | | | | | |
|----|---|----------------|----|--|--------------|
| 34 | DRIVE button..... | 9 | 47 | Memory card slot cover (detachable) | 6, 42 |
| | ⏏ (delete) button..... | 62 | | | |
| 35 | ▶ (playback) button..... | 59 | 48 | Battery-chamber cover latch..... | 40 |
| 36 | Eye sensor..... | 19 | 49 | Battery-chamber cover..... | 40 |
| 37 | Electronic viewfinder (EVF) | 14, 18, 20, 31 | 50 | Selector buttons..... | 7 |
| 38 | Eye cup (lockable)..... | 13 | 51 | MENU/OK button..... | 28 |
| 39 | VIEW MODE button..... | 18 | 52 | DISP (display)/BACK button..... | 21, 217 |
| 40 | Secondary monitor backlight button..... | 27 | | Ⓜ (Bluetooth) button | |
| 41 | Focus stick (focus lever)..... | 7, 97, 270 | 53 | Q (quick menu) button..... | 291 |
| 42 | AFON button..... | 110, 297 | 54 | AEL (exposure lock) button..... | 110, 297 |
| 43 | Rear command dial..... | 10, 219, 272 | 55 | Tripod mount | |
| 44 | Indicator lamp..... | 11, 197 | 56 | LCD monitor..... | 12, 16, 18 |
| | Tally light..... | 197 | | Touch screen..... | 31, 164, 207 |
| 45 | Remote release connector cover..... | 81 | 57 | File transmitter/vertical battery grip | |
| 46 | Memory card slot cover latch..... | 42 | | connector cover..... | 330 |

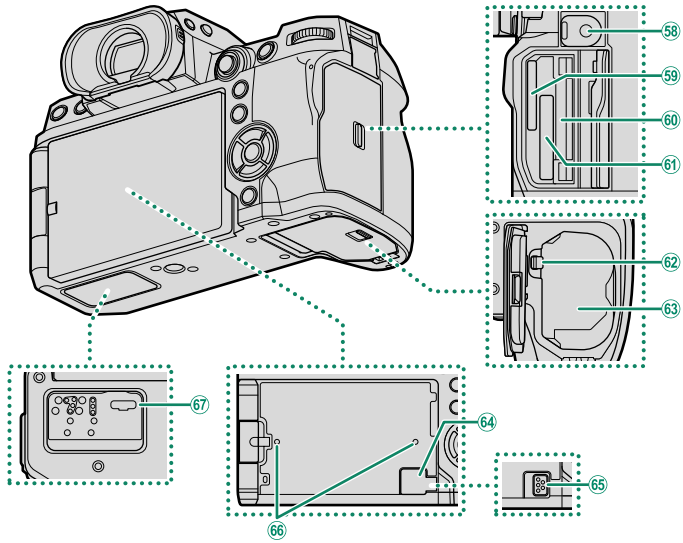

58 Remote release connector (ø2.5mm).....81	63 Battery chamber.....40
59 Memory card slot 2 (for SD memory cards).....42	64 Cooling fan connector cover.....336
60 Serial number plate.....6	65 Cooling fan connector.....336
61 Memory card slot 1 (for Type B CFexpress cards).....42	66 Hole to screw cooling fan.....336
62 Battery latch.....41	67 File transmitter/vertical battery grip connector.....330

The Cable Protector

Attach the protector as shown to prevent accidental disconnection.

- ① Slide the protector over the USB connector cover so that the cover passes through the slot in the protector.
- ② Tighten the lock screw.
- ③ Connect the cable and pass it through the protector as shown.

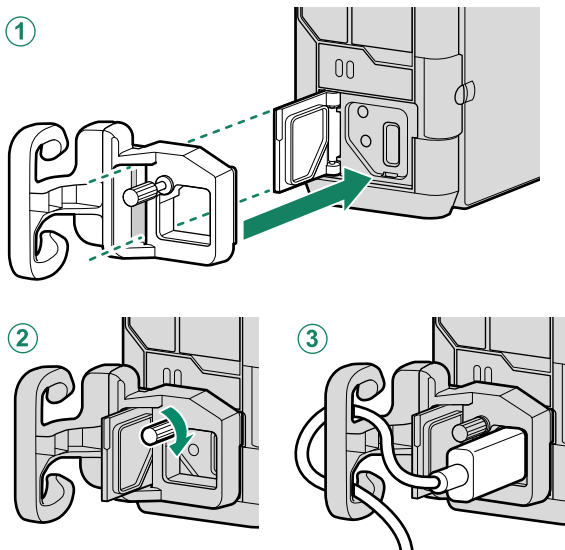

The Serial Number Plate

Do not remove the serial number plate, which provides the CMIIT ID, serial number, and other important information.

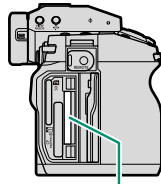

Serial number plate

The Memory Card Slot Cover (Detachable)

The memory card slot cover can be removed by lowering the interior latch. Remove the cover for ease of access when a camera rig is attached or in other situations that make it difficult to open or close the cover.

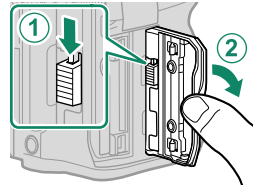

The Focus Stick (Focus Lever)

Tilt or press the focus stick to select the focus area. The focus stick can also be used to navigate the menus.

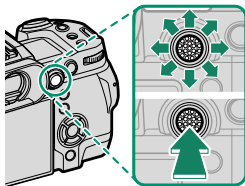

 To choose the role played by the focus stick, press and hold the center of the stick or use **FUNCTION/DIAL SETTING > FOCUS LEVER SETTING**.

The Selector

Press the selector up (**▲**), right (**▶**), down (**▼**), or left (**◀**) to highlight items. The up, right, down, and left buttons also double as function buttons **Fn4** through **Fn7**.

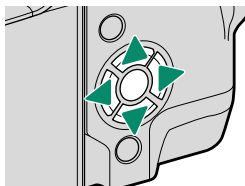

The WB Button

Press the **WB** button to access white balance settings.

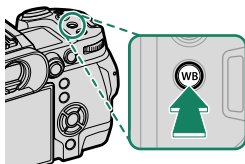

The Mode Dial

To select a shooting mode, rotate the dial until the icon for the desired mode aligns with the index.

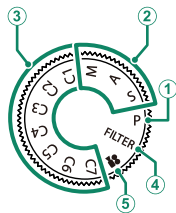







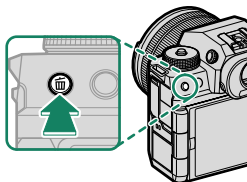



Mode	Description	
① P (PROGRAM AE)	Aperture and shutter speed can be adjusted using program shift.	72
② S (SHUTTER PRIORITY AE) A (APERTURE PRIORITY AE) M (MANUAL)	Select for full control over camera settings, including aperture (M and A) and/or shutter speed (M and S).	74 76 78
③ C1/C2/C3/C4/C5/C6/C7 (CUSTOM 1/2/3/4/5/6/7)	Take pictures using previously-stored settings.	83
④ FILTER (FILTER)	Take photos with filter effects.	82
⑤  (MOVIE)	Record movies.	64

The DRIVE Button

Pressing the **DRIVE** button displays drive-mode menu, where you can choose from the following the drive modes.



Mode			Mode		
	Single frame	56	BKT	Bracketing	115
	High-speed burst	111		HDR	118
	Low-speed burst	111		Panorama	120
	ISO BKT	114		Multiple Exposure	123
	WHITE BALANCE BKT	114		PIXEL SHIFT MULTI SHOT	125

The Command Dials

The rear and front command dials are used for the operations below.

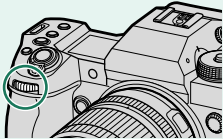
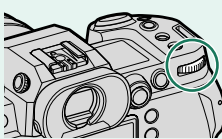
		Front command dial	Rear command dial
			
Shooting ¹	P	Choose the desired combination of shutter speed and aperture (program shift).	Adjust exposure compensation.
	S	Choose a shutter speed.	
	A	Adjust aperture. ²	
	M	Choose a shutter speed.	Adjust aperture. ²
	FILTER	Program shift.	Adjust exposure compensation.
Menus	Select menu tabs or page through menus.	Highlight menu items.	
Q Menu	Select items in the quick menu.	Adjust settings in the quick menu.	
Playback	View other pictures.	<ul style="list-style-type: none"> • Zoom in or out (full-frame playback). • Zoom in or out (multi-frame playback). 	

1 Can be changed using **Q** **BUTTON/DIAL SETTING** > **COMMAND DIAL SETTING**.

2 Applies if the lens has no aperture ring or if an aperture ring with an "A" position is in the **A** position.

 The rotation direction for the command dials can be selected using **Q** **BUTTON/DIAL SETTING** > **COMMAND DIAL DIRECTION**.

The Indicator Lamp

Camera status is shown by the indicator lamp.

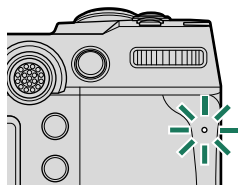

Indicator lamp	Camera status
Glows green	Focus locked.
Blinks green	Focus or slow shutter speed warning. Pictures can be taken.
Blinks green and orange	<ul style="list-style-type: none"> • Camera on: Recording pictures, or picture displayed for confirmation after being taken with option other than OFF selected for SCREEN SETTING > IMAGE DISP. (additional pictures can be taken). • Camera off: Uploading pictures to a smartphone or tablet.*
Glows orange	Recording pictures. No additional pictures can be taken at this time.
Blinks orange	Flash charging; flash will not fire when picture is taken.
Blinks red	Lens or memory error.

* Displayed only if pictures are selected for upload.

- Warnings may also appear in the display.
- The indicator lamp remains off while your eye is to the viewfinder.
- The **MOVIE SETTING > TALLY LIGHT** option can be used to choose the lamp (indicator or AF-assist) that lights during movie recording and whether the lamp blinks or remains steady.

The LCD Monitor

You can adjust the angle of the LCD monitor when framing shots, but be careful not to trap your fingers or other objects.

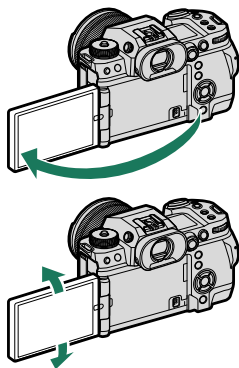

- ⚠ Do not apply excessive force to the hinge when rotating the LCD monitor, as this could damage the hinge.
- Be careful that the corners of the monitor do not contact the camera body, as this could leave marks.

📖 The LCD monitor also functions as a touch screen that can be used for:

- Touch photography (📖 32)
- Focus area selection (📖 31)
- Function selection (📖 34)
- Movie optimized control  (📖 33)
- Playback (📖 36)

The Eye Cup

To remove the eye cup, hold the buttons on either side and slide eye cup up.

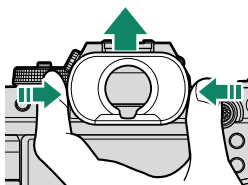

Focusing the Viewfinder

If the indicators displayed in the viewfinder are blurred, put your eye to the viewfinder and rotate the diopter adjustment control until the display is in sharp focus.

To focus the viewfinder:

- ① Lift the diopter adjustment control.
- ② Rotate the control to adjust viewfinder focus.
- ③ Return the control to its original position and lock it in place.

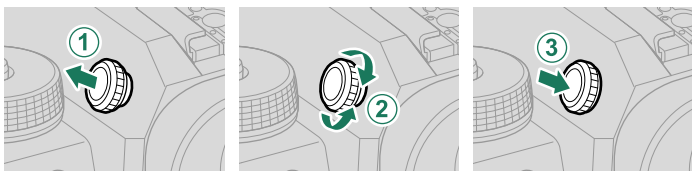

! Lift the control before use. Failure to observe this precaution could cause product malfunction.

Camera Displays

This section lists the indicators that may be displayed during shooting.

! For illustrative purposes, displays are shown with all indicators lit.

The Electronic Viewfinder

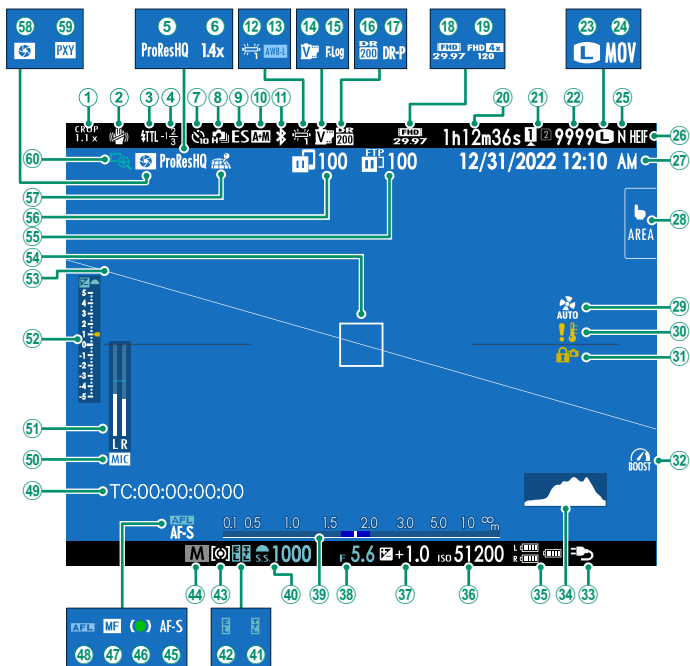

① Crop factor.....	192	③① Control lock ³	280
② IS mode ²	175	③② Boost mode.....	282
③ Flash (TTL) mode.....	322	③③ Power supply.....	48
④ Flash compensation.....	322	③④ Histogram.....	24
⑤ Movie compression.....	188	③⑤ Battery level.....	51
⑥ Digital teleconverter.....	175	③⑥ Sensitivity.....	105
⑦ Self-timer indicator.....	168	③⑦ Exposure compensation.....	108
⑧ Continuous mode.....	111	③⑧ Aperture.....	73, 76, 78
⑨ Shutter type.....	173	③⑨ Distance indicator ²	102
⑩ AF+MF indicator ²	159	④⑩ Shutter speed.....	73, 74, 78
⑪ Bluetooth ON/OFF.....		④① TTL lock.....	178, 302
⑫ White balance.....	136	④② AE lock.....	110, 276
⑬ AWB lock.....	276	④③ Metering.....	107
⑭ Film simulation.....	132	④④ Shooting mode.....	72
⑮ F-Log/HLG recording.....	193	④⑤ Focus mode ²	92
⑯ Dynamic range.....	140	④⑥ Focus indicator ²	93
⑰ D-range priority.....	140	④⑦ Manual focus indicator ²	92, 100
⑱ Movie mode.....	64, 185	④⑧ AF lock.....	110, 276
⑲ High-speed recording indicator.....	186	④⑨ Time code.....	212
⑳ Recording time available/ elapsed recording time.....	64	⑤⑩ Microphone input channel.....	183, 211
㉑ Card slot options.....	44, 284	⑤① Recording level ²	209
㉒ Number of available frames ¹	371	⑤② Exposure indicator.....	78, 108
㉓ Image size.....	128	⑤③ Virtual horizon.....	25
㉔ File format.....	188	⑤④ Focus frame.....	96, 109
㉕ Image quality.....	129	⑤⑤ FTP upload progress.....	244
㉖ HEIF format.....	131	⑤⑥ Image transfer status.....	
㉗ Date and time.....	52, 54, 247	⑤⑦ Location data download status.....	286
㉘ Touch screen mode.....	31, 164	⑤⑧ Depth-of-field preview.....	77, 102
㉙ Cooling fan settings.....	176, 198	⑤⑨ Proxy setting (ProRes only).....	190
㉚ Temperature warning.....	43, 370	⑥⑩ Focus check.....	103, 160

1 Shows "9999" if there is space for over 9999 frames.

2 Not displayed when **ON** is selected for **SCREEN SET-UP > LARGE INDICATORS MODE(EVF)**.

3 Displayed when controls have been locked by pressing and holding the **MENU/OK** button. Control lock can be ended by pressing and holding the **MENU/OK** button again.

The LCD Monitor

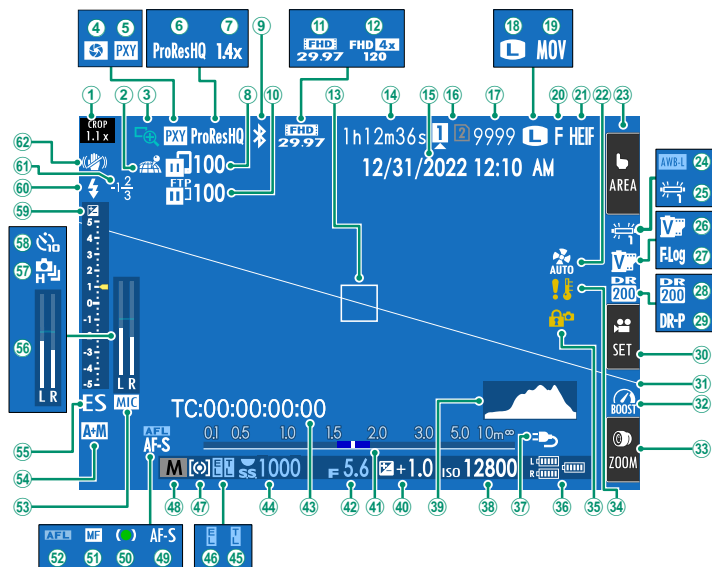

① Crop factor.....	192	③② Boost mode.....	282
② Location data download status.....	286	③③ Touch zoom ³	35
③ Focus check.....	103, 160	③④ Temperature warning.....	43, 370
④ Depth-of-field preview.....	77, 102	③⑤ Control lock ⁴	280
⑤ Proxy setting (ProRes only).....	190	③⑥ Battery level.....	51
⑥ Movie compression.....	188	③⑦ Power supply.....	48
⑦ Digital teleconverter.....	175	③⑧ Sensitivity.....	105
⑧ Image transfer status		③⑨ Histogram.....	24
⑨ Bluetooth ON/OFF		④① Exposure compensation.....	108
⑩ FTP upload progress.....	244	④② Distance indicator ²	102
⑪ Movie mode.....	64, 185	④③ Aperture.....	73, 76, 78
⑫ High-speed recording indicator.....	186	④④ Time code.....	212
⑬ Focus frame.....	96, 109	④⑤ Shutter speed.....	73, 74, 78
⑭ Recording time available/ elapsed recording time.....	64	④⑥ TTL lock.....	178, 302
⑮ Date and time.....	52, 54, 247	④⑦ AE lock.....	110, 276
⑯ Card slot options.....	44, 284	④⑧ Metering.....	107
⑰ Number of available frames ¹	371	④⑨ Shooting mode.....	72
⑱ Image size.....	128	④⑩ Focus mode ²	92
⑲ File format.....	188	⑤① Focus indicator ²	93
⑳ Image quality.....	129	⑤② Manual focus indicator ²	92, 100
㉑ HEIF format.....	131	⑤③ AF lock.....	110, 276
㉒ Cooling fan settings.....	176, 198	⑤④ Microphone input channel.....	183, 211
㉓ Touch screen mode ³	31, 164	⑤⑤ AF+MF indicator ²	159
㉔ AWB lock.....	276	⑤⑥ Shutter type.....	173
㉕ White balance.....	136	⑤⑦ Recording level ²	209
㉖ Film simulation.....	132	⑤⑧ Continuous mode.....	111
㉗ F-Log/HLG recording.....	193	⑤⑨ Self-timer indicator.....	168
㉘ Dynamic range.....	140	⑤⑩ Exposure indicator.....	78, 108
㉙ D-range priority.....	140	⑥① Flash (TTL) mode.....	322
⑳① Movie optimized control ³	33	⑥② Flash compensation.....	322
⑳② Virtual horizon.....	25	⑥③ IS mode ²	175

1 Shows "9999" if there is space for over 9999 frames.

2 Not displayed when **ON** is selected for **SCREEN SET-UP > LARGE INDICATORS MODE(LCD)**.

3 Camera functions can also be accessed via touch controls.



4 Displayed when controls have been locked by pressing and holding the **MENU/OK** button. Control lock can be ended by pressing and holding the **MENU/OK** button again.

Choosing a Display Mode

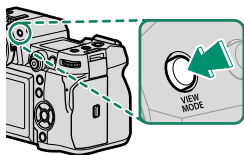
Press the **VIEW MODE** button to cycle through the following display modes. You can choose separate display modes for shooting and playback.



SHOOTING

Option	Description
 EYE SENSOR	Putting your eye to the viewfinder turns the viewfinder on and the LCD monitor off; taking your eye away turns the viewfinder off and LCD monitor on.
LCD ONLY	LCD monitor on, viewfinder off.
EVF ONLY	Viewfinder on, LCD monitor off.
EVF ONLY + 	Putting your eye to the viewfinder turns the viewfinder on; taking it away turns the viewfinder off. The LCD monitor remains off.
 EYE SENSOR + LCD IMAGE DISP.	Putting your eye to the viewfinder during shooting turns the viewfinder on, but the LCD monitor is used for the display of images once you remove your eye from the viewfinder after shooting. The options selected for SCREEN SET-UP > IMAGE DISP. apply to display in the LCD monitor.

PLAYBACK

Option	Description
 EYE SENSOR	Putting your eye to the viewfinder turns the viewfinder on and the LCD monitor off; taking your eye away turns the viewfinder off and LCD monitor on.
LCD ONLY	LCD monitor on, viewfinder off.
EVF ONLY	Viewfinder on, LCD monitor off.

- Use  **SCREEN SET-UP > VIEW MODE SETTING** in the setup menu to choose a display mode for the EVF and LCD monitor.
- **EVF/LCD SWITCH** can be assigned to a function button and the button then used to switch between the **EVF ONLY** and **LCD ONLY** displays.

The Eye Sensor

The eye sensor may respond to objects other than your eye or to light shining directly on the sensor.

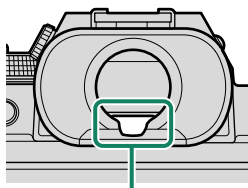

Eye sensor

Adjusting Display Brightness

The brightness and saturation of the viewfinder and LCD monitor can be adjusted using the items in the **SCREEN SET-UP** menu. Choose **EVF BRIGHTNESS** or **EVF COLOR** to adjust viewfinder brightness or saturation, **LCD BRIGHTNESS** or **LCD COLOR** to do the same for the LCD monitor.

Display Rotation

When **ON** is selected for **SCREEN SET-UP > AUTOROTATE DISPLAYS**, the indicators in the viewfinder and LCD monitor automatically rotate to match camera orientation.

The DISP/BACK Button

The **DISP/BACK** button controls the display of indicators in the viewfinder and LCD monitor.

Indicators for the EVF and LCD must be selected separately. To choose the EVF display, place your eye to the viewfinder while using the **DISP/BACK** button.

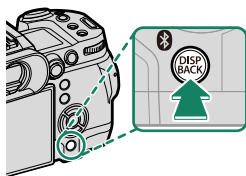

Viewfinder

Full screen

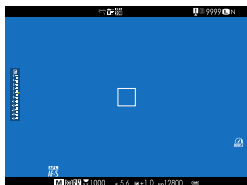

Standard indicators

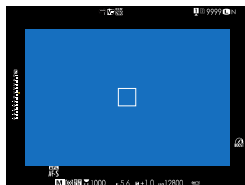

*Dual display
(manual focus mode only)*

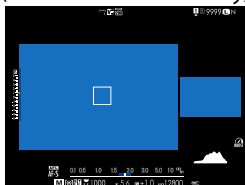

LCD Monitor

Standard indicators

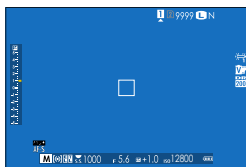

No indicators

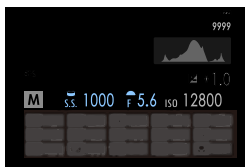
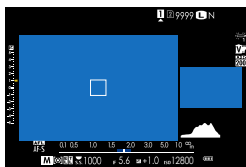

Dual display
(manual focus mode only)

Info display

The Dual Display

The dual display consists of a large full-frame window and a smaller close-up of the focus area.

Customizing the Standard Display

To choose the items shown in the standard indicator display:

- 1 Display standard indicators.**
Use the **DISP/BACK** button to display standard indicators.
- 2 Select DISP. CUSTOM SETTING.**
Select **SCREEN SET-UP > DISP. CUSTOM SETTING** in the setup menu.
- 3 Choose items.**
Highlight items and press **MENU/OK** to select or deselect.

Item	Default		Item	Default	
	STILL	MOVIE		STILL	MOVIE
FRAMING GUIDELINE	<input type="checkbox"/>	<input type="checkbox"/>	DUAL IS MODE	<input checked="" type="checkbox"/>	<input checked="" type="checkbox"/>
FOCUS FRAME	<input checked="" type="checkbox"/>	<input checked="" type="checkbox"/>	TOUCH SCREEN MODE	<input checked="" type="checkbox"/>	<input checked="" type="checkbox"/>
AF DISTANCE INDICATOR	<input type="checkbox"/>	<input type="checkbox"/>	WHITE BALANCE	<input checked="" type="checkbox"/>	<input checked="" type="checkbox"/>
MF DISTANCE INDICATOR	<input checked="" type="checkbox"/>	<input checked="" type="checkbox"/>	FILM SIMULATION	<input checked="" type="checkbox"/>	<input checked="" type="checkbox"/>
HISTOGRAM	<input type="checkbox"/>	<input type="checkbox"/>	DYNAMIC RANGE	<input checked="" type="checkbox"/>	<input checked="" type="checkbox"/>
LIVE VIEW HIGHLIGHT ALERT	<input type="checkbox"/>	<input type="checkbox"/>	BOOST MODE	<input checked="" type="checkbox"/>	<input checked="" type="checkbox"/>
SHOOTING MODE	<input checked="" type="checkbox"/>	<input checked="" type="checkbox"/>	COOLING FAN SETTING	<input checked="" type="checkbox"/>	<input checked="" type="checkbox"/>
APERTURE/S-SPEED/ISO	<input checked="" type="checkbox"/>	<input checked="" type="checkbox"/>	FRAMES REMAINING	<input checked="" type="checkbox"/>	—
INFORMATION BACKGROUND	<input checked="" type="checkbox"/>	<input checked="" type="checkbox"/>	IMAGE SIZE/QUALITY	<input checked="" type="checkbox"/>	—
Expo. Comp. (Digit)	<input type="checkbox"/>	<input type="checkbox"/>	MOVIE MODE & REC. TIME	—	<input checked="" type="checkbox"/>
Expo. Comp. (Scale)	<input checked="" type="checkbox"/>	<input checked="" type="checkbox"/>	DIGITAL TELE-CONV.	<input checked="" type="checkbox"/>	—
FOCUS MODE	<input checked="" type="checkbox"/>	<input checked="" type="checkbox"/>	IMAGE TRANSFER ORDER	<input checked="" type="checkbox"/>	<input checked="" type="checkbox"/>
PHOTOMETRY	<input checked="" type="checkbox"/>	<input checked="" type="checkbox"/>	MIC LEVEL	—	<input checked="" type="checkbox"/>
SHUTTER TYPE	<input checked="" type="checkbox"/>	—	GUIDANCE MESSAGE	<input checked="" type="checkbox"/>	<input checked="" type="checkbox"/>
FLASH	<input checked="" type="checkbox"/>	—	BATTERY LEVEL	<input checked="" type="checkbox"/>	<input checked="" type="checkbox"/>
CONTINUOUS MODE	<input checked="" type="checkbox"/>	—	FRAMING OUTLINE	<input type="checkbox"/>	<input type="checkbox"/>

- 4 Press DISP/BACK to save changes.**
- 5 Press DISP/BACK as needed to exit the menus and return to the shooting display.**

Framing Outline

Enable **FRAMING OUTLINE** to make the borders of the frame easier to see against dark backgrounds.

Histograms

Histograms show the distribution of tones in the image. Brightness is shown by the horizontal axis, the number of pixels by the vertical axis.

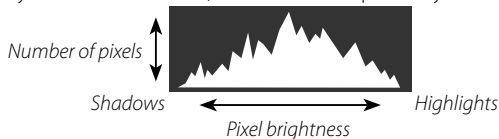

- **Optimal exposure:** Pixels are distributed in an even curve throughout the tone range.
- **Overexposed:** Pixels are clustered on the right side of the graph.
- **Underexposed:** Pixels are clustered on the left side of the graph.

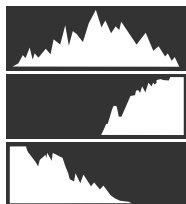

To view separate RGB histograms and a display showing areas of the frame that will be overexposed at current settings superimposed on the view through the lens, press the function button to which **HISTOGRAM** is assigned (📖 271, 297).

- ① *Overexposed areas blink*
- ② *RGB histograms*

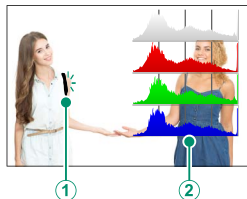

Virtual Horizon

Check whether the camera is level. The display type can be chosen using **SCREEN SET-UP > ELECTRONIC LEVEL SETTING**. Use the virtual horizon to level the camera when mounting it on a tripod or the like.

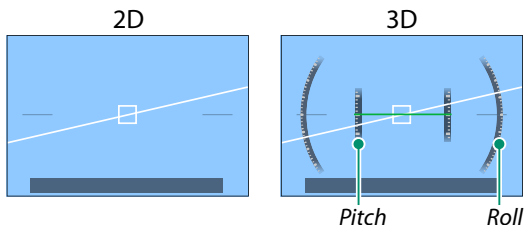

- **OFF:** The virtual horizon is not displayed.
- **2D:** A white line shows the amount the camera is tilted left or right. The line turns green when the camera is level. The line may vanish if the camera is tilted forward or back.
- **3D:** The display shows whether the camera is tilted left or right and forward or back.

ELECTRONIC LEVEL SWITCH can be assigned to a function button and the button then used to switch between the 2D and 3D displays.

The Secondary LCD Monitor

Among the settings that can be viewed in the secondary LCD monitor are shutter speed, aperture, and ISO sensitivity. Different settings are displayed in still photography and movie modes.

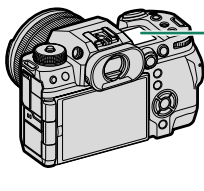

Secondary LCD monitor

Default Settings

By default, the secondary LCD monitor displays the settings listed below.

 The settings displayed can be selected using **SCREEN SET-UP > SUB MONITOR SETTING.**

Still Photography Mode

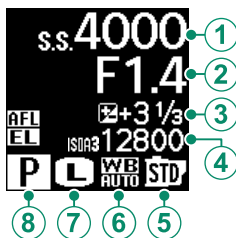

Default

① SHUTTER SPEED	⑤ FILM SIMULATION
② APERTURE	⑥ WHITE BALANCE
③ EXPO. COMP.	⑦ IMAGE SIZE
④ ISO	⑧ SHOOTING MODE

Movie Mode

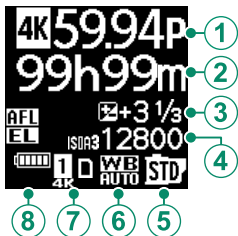

Default	
① MOVIE MODE	⑤ FILM SIMULATION
② REC. TIME	⑥ WHITE BALANCE
③ EXPO. COMP.	⑦ CARD SLOT OPTIONS
④ ISO	⑧ BATTERY LEVEL

The Secondary Monitor Backlight Button

To turn on the secondary LCD monitor backlight when you find the secondary LCD monitor too dark to read, press the secondary monitor backlight button. Press the button again to turn the backlight off.

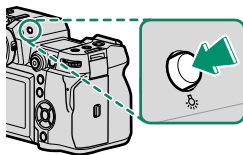

Background Color

The background color (black or white) for the secondary LCD monitor can be selected using the **SCREEN SET-UP > SUB MONITOR BACKGROUND COLOR** option in the **(setup)** menu. Note that the background is displayed in white whenever the secondary LCD monitor backlight is on.

Using the Menus

To display the menu, press **MENU/OK**.

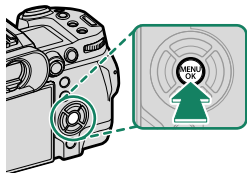

The Menu

Different menus are displayed during still photography, movie recording, and playback.

Still Photography (All Modes Except)

Pressing **MENU/OK** during still photography displays the photo menu.

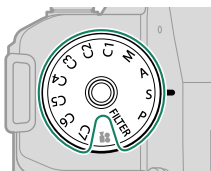

 In modes **C1** through **C7**, photo menu will be displayed if  **STILL** is selected for the chosen bank using either  **IMAGE QUALITY SETTING** >   **CUSTOM MODE SETTING** in the photo menu or  **MOVIE SETTING** >   **CUSTOM MODE SETTING** in the movie menu (83).

Movie Recording (🎥/Movie Mode)

Pressing **MENU/OK** in movie mode displays the movie menus.

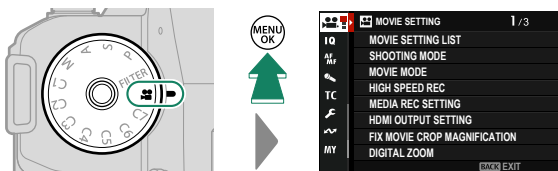

In modes **C1** through **C7**, photo menus will be displayed if **MOVIE** is selected for the chosen bank using either **IMAGE QUALITY SETTING > CUSTOM MODE SETTING** in the photo menus or **MOVIE SETTING > CUSTOM MODE SETTING** in the movie menus (83).

Playback

Pressing **MENU/OK** during playback displays the playback menu.

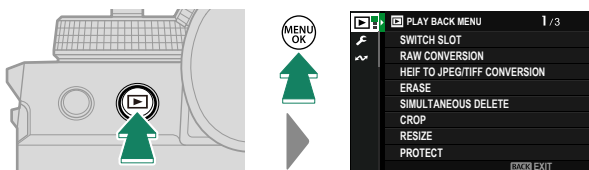

Selecting a Menu Tab

To navigate the menus:

- 1 Press **MENU/OK** to display the menus.

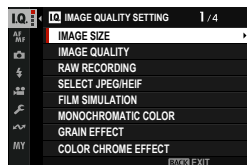
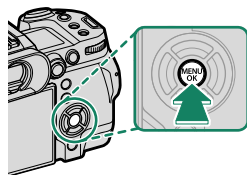

- 2 Press the focus stick (focus lever) left to highlight the tab for the current menu.



Tab

- 3 Press the focus stick up or down to highlight the tab containing the desired item.
- 4 Press the focus stick right to place the cursor in the menu.

 Use the front command dial to select menu tabs or page through menus and the rear command dial to highlight menu items.

Touch Screen Mode

The LCD monitor also functions as a touch screen.

Shooting Touch Controls

To enable touch controls, select **ON** for **☑️ BUTTON/DIAL SETTING > TOUCH SCREEN SETTING > 📷 TOUCH SCREEN SETTING**.

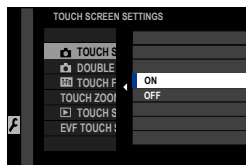

EVF

The LCD monitor can be used to select the focus area while pictures are being framed in the electronic viewfinder (EVF). Use **☑️ BUTTON/DIAL SETTING > TOUCH SCREEN SETTING > EVF TOUCH SCREEN AREA SETTINGS** to choose the area of the monitor employed for touch controls.

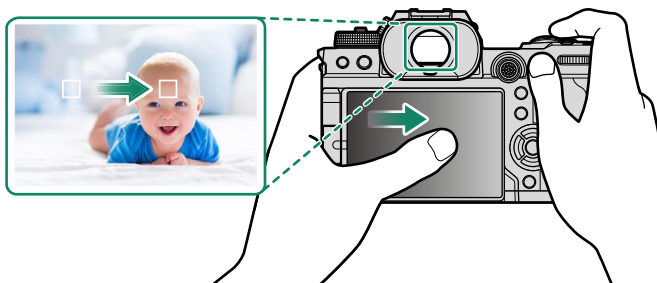



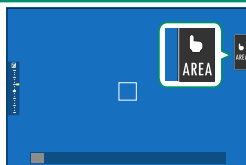

- When **FACE DETECTION ON** is selected for **AF/MF AF/MF SETTING > 📷 FACE/EYE DETECTION SETTING**, you can choose the face used for focus.
- You can choose the type of subject on which the camera preferentially focuses when **SUBJECT DETECTION ON** is selected for **AF/MF AF/MF SETTING > SUBJECT DETECTION SETTING**.

LCD Monitor

The operation performed can be selected by tapping the touch screen mode indicator in the display. Touch controls can be used for the following operations:



Mode	Description
 TOUCH SHOOTING	Tap your subject in the display to focus and release the shutter. In burst mode, pictures will be taken while you keep your finger on the display.
 AF ↓ ↑  AF OFF	<ul style="list-style-type: none">• If SINGLE AF is selected for focus mode, the camera will focus when you tap your subject in the display. Focus locks at the current distance until you tap the AF OFF icon.• If CONTINUOUS AF is selected for focus mode, the camera will initiate focus when you tap your subject in the display. The camera will continue to adjust focus for changes in the distance to the subject until you tap the AF OFF icon.• When MANUAL FOCUS is selected for focus mode, you can tap the display to focus on the selected subject using autofocus.
 AREA	Tap to select a point for focus or zoom. The focus frame will move to the selected point.
 OFF	Touch controls disabled.

! Different touch controls are used during focus zoom (📖 165).



- To disable touch controls and hide the touch screen mode indicator, select **OFF** for **🔧 BUTTON/DIAL SETTING > TOUCH SCREEN SETTING > 📷 TOUCH SCREEN SETTING**.
- Touch control settings can be adjusted using **🔧 AF/MF SETTING > TOUCH SCREEN MODE**. For information on the touch controls available during movie recording, see “Movie Recording (📷 **TOUCH SCREEN MODE**; 📖 207)”.

MOVIE OPTIMIZED CONTROL

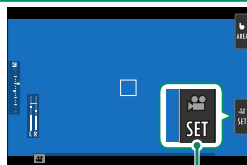
Selecting **ON** for **MOVIE SETTING** > **MOVIE OPTIMIZED CONTROL**  or tapping the movie-optimized mode button in the shooting display optimizes the command dials and touch controls for movie recording. This can be used to prevent camera sounds being recorded with movie footage.



Movie-optimized mode button

- SHUTTER SPEED
- APERTURE
- EXPOSURE COMPENSATION
- ISO
- INTERNAL MIC LEVEL
- ADJUSTMENT/EXTERNAL MIC LEVEL ADJUSTMENT
- WIND FILTER
- HEADPHONES VOLUME
-  FILM SIMULATION
-  WHITE BALANCE
-  IS MODE
-  IS MODE BOOST
-  FOCUS MODE

-  • Enabling movie-optimized controls disables the aperture ring.
- When movie-optimized control is enabled, the movie-optimized mode button can be used to change shooting settings or disable movie-optimized control.

Touch Function

Functions can be assigned to the following flick gestures in much the same way as function buttons (📖 297):

- Flick up: **T-Fn1**
- Flick left: **T-Fn2**
- Flick right: **T-Fn3**
- Flick down: **T-Fn4**

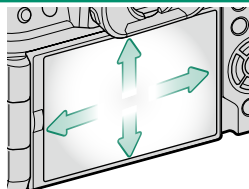

- In some cases, touch-function flick gestures display a menu; tap to select the desired option.

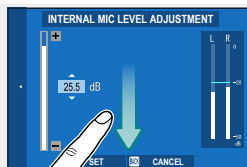

- Touch-function gestures are disabled by default. To enable touch-function gestures, select **ON** for **🔘 BUTTON/DIAL SETTING > TOUCH SCREEN SETTING > T-Fn TOUCH FUNCTION**.



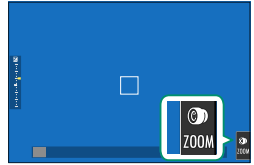

Touch Zoom

If the lens supports touch zoom, you can zoom in and out by touching the display. Tap the touch zoom button in the display to enable touch zoom.

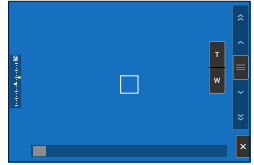

Touch zoom is controlled using the buttons in the display.



Button	Description
 Touch zoom	Enable touch zoom.
 Zoom in	Zoom in or out. Touch and hold to zoom in or out at a constant speed.
 Zoom out	
 Rocker switch	Swipe to choose a zoom position. Touch and hold to zoom in or out at a speed corresponding where you put your finger.
 Disable	Disable touch zoom.

Playback Touch Controls

When **ON** is selected for **▶️ BUTTON/DIAL SETTING > TOUCH SCREEN SETTING > ▶️ TOUCH SCREEN SETTING**, touch controls can be used for the following playback operations:

- **Swipe:** Swipe a finger across the display to view other images.



- **Pinch-out:** Place two fingers on the display and spread them apart to zoom in.



- **Pinch-in:** Place two fingers on the display and slide them together to zoom out.



Pictures can be zoomed out until the entire image is visible but no further.

- **Double-tap:** Tap the display twice to zoom in on the focus point.



- **Drag:** View other areas of the image during playback zoom.



First Steps

2

Attaching the Strap

Attach the strap.

Attach the strap to the two strap eyelets as shown below.

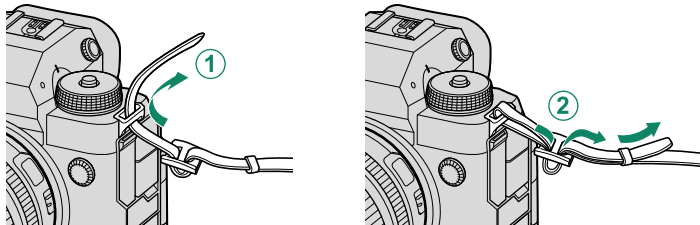

! To avoid dropping the camera, be sure the strap is correctly secured.

Attaching a Lens

The camera can be used with lenses for the FUJIFILM X-mount.

Remove the body cap from the camera and the rear cap from the lens. Place the lens on mount, keeping the marks on the lens and camera aligned (①), and then rotate the lens until it clicks into place (②).

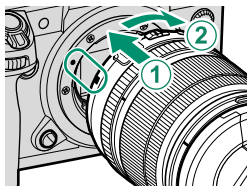

- ❗ When attaching lenses, ensure that dust or other foreign matter does not enter the camera.
- Be careful not to touch the camera's internal parts.
- Rotate the lens until it clicks securely into place.
- Do not press the lens release button while attaching the lens.

Removing Lenses

To remove the lens, turn the camera off, then press the lens release button (①) and rotate the lens as shown (②).

- ❗ To prevent dust accumulating on the lens or inside the camera, replace the lens caps and camera body cap when the lens is not attached.

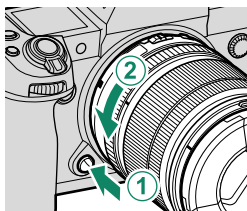

Lenses and Other Optional Accessories

The camera can be used with lenses and accessories for the FUJIFILM X-mount.

- ❗ Observe the following precautions when attaching or removing (exchanging) lenses.
- Check that the lenses are free of dust and other foreign matter.
- Do not change lenses in direct sunlight or under another bright light source. Light focused into the interior of the camera could cause it to malfunction.
- Attach the lens caps before exchanging lenses.
- See the manual provided with the lens for information on use.

Inserting the Battery

Insert the battery in the camera as described below.

1 Open the battery-chamber cover.

Slide the battery-chamber cover latch as shown and open the battery-chamber cover.

- Do not open the battery-chamber cover when the camera is on. Failure to observe this precaution could damage image files or memory cards.
- Do not use excessive force when handling the battery-chamber cover.

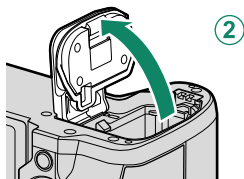
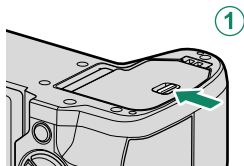

2 Insert the battery as shown.

- Insert the battery in the orientation shown. *Do not use force or attempt to insert the battery upside down or backwards.*
- Confirm that the battery is securely latched.

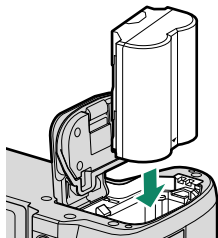

3 Close the battery-chamber cover.

Close and latch the cover.

 If the cover does not close, check that the battery is in the correct orientation. Do not attempt to force the cover shut.

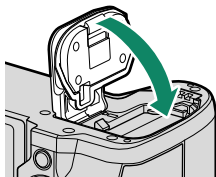

Removing the Battery

Before removing the battery, *turn the camera off* and open the battery-chamber cover.

To remove the battery, press the battery latch to the side, and slide the battery out of the camera as shown.

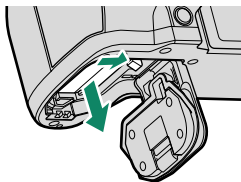

 The battery may become hot when used in high-temperature environments. Observe caution when removing the battery.

Inserting Memory Cards

Pictures are stored on memory cards (sold separately).

 The camera is equipped with two memory card slots. Use Slot 1 with CFexpress cards and Slot 2 with SD, SDHC, or SDXC cards.

1 Open the memory card slot cover.

Unlatch and open the cover.

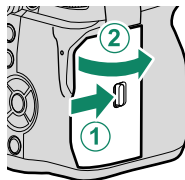

 Do not turn the camera off or remove the memory card while the memory card is being formatted or data are being recorded to or deleted from the card. Failure to observe this precaution could damage the card.

2 Insert the memory card.

Holding the card in the orientation shown, slide it in until it clicks into place at the back of the slot. Close and latch the memory card slot cover.

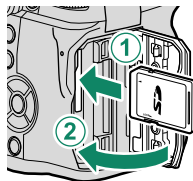

 Be sure card is in the correct orientation; do not insert at an angle or use force.

Removing Memory Cards



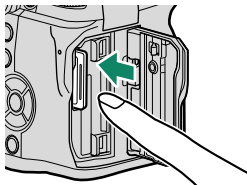

Turn the camera off and open the memory card slot cover. Eject the card by pressing it in with a finger and then slowly releasing it; the card can then be removed by hand.



- ❗ • Press the center of the card.
- Suddenly removing your finger from the card could cause the card to fall from the slot. Remove your finger slowly.
- If the camera displays a !⚡ icon, the memory card may be hot to the touch. Wait for the card to cool before removing it.

Using Two Cards

The camera can be used with two cards, one in each of its two slots. At default settings, photos are saved to the card in the second slot only when the card in the first slot is full. This can be changed using **SAVE DATA SET-UP > CARD SLOT SETTING**.

Option	Description	Display
SEQUENTIAL (default)	The card in the second slot is used only when the card in the first slot is full. If the second slot is selected for SAVE DATA SET-UP > SELECT SLOT (SEQUENTIAL) , recording will start on the card in the second slot and switch to the first slot when the card in the second slot is full.	
BACKUP	Each picture is recorded twice, once to each card.	
SEPARATE	RAW pictures are recorded to the card in the first slot and JPEG or HEIF pictures to the card in the second slot. This setting takes effect only when FINE + RAW or NORMAL + RAW is selected for IMAGE QUALITY SETTING > IMAGE QUALITY .	 RAW+JPEG  RAW+HEIF

The card used to store movies can be selected using **MOVIE SETTING > MEDIA REC SETTING**.

Compatible Memory Cards

- The camera can be used with SD, SDHC, SDXC, and CFexpress Type B memory cards. Both the UHS-I and UHS-II bus interfaces are supported.
- CFexpress or UHS-II memory cards are recommended for high-speed burst photography.
- The types of memory cards suitable for movie recording vary with the settings selected (📖 68).
- A list of supported memory cards is available on the Fujifilm website. For details, visit:
<https://fujifilm-x.com/support/compatibility/cameras/>.

⚠ • Do not turn the camera off or remove the memory card while the memory card is being formatted or data are being recorded to or deleted from the card. Failure to observe this precaution could damage the card.

- Memory cards can be locked, making it impossible to format the card or to record or delete images. Before inserting a memory card, slide the write-protect switch to the unlocked position.



- Memory cards are small and can be swallowed; keep out of reach of children. If a child swallows a memory card, seek medical assistance immediately.
- miniSD or microSD adapters that are larger or smaller than memory cards may not eject normally; if the card does not eject, take the camera to an authorized service representative. Do not forcibly remove the card.
- Do not affix labels or other objects to memory cards. Peeling labels can cause camera malfunction.
- Movie recording may be interrupted with some types of memory card.
- Formatting a memory card in the camera creates a folder in which pictures are stored. Do not rename or delete this folder or use a computer or other device to edit, delete, or rename image files. Always use the camera to delete pictures; before editing or renaming files, copy them to a computer and edit or rename the copies, not the originals. Renaming the files on the camera can cause problems during playback.

Charging the Battery

For reasons of safety, the battery is not charged at shipment. The camera will not function if the battery is not charged; be sure to charge the battery before use. Before charging the battery, turn the camera off.

- An NP-W235 rechargeable battery is supplied with the camera.
- Charging takes about 180 minutes.

1 Attach the plug adapter to the AC power adapter.

Attach the plug adapter as shown, making sure that it is fully inserted and clicks into place on the AC power adapter terminals.

- The supplied plug adapter is for use exclusively with the AC-5VJ AC power adapter. Do not use it with other devices.
- The shape of the plug adapter varies with the country of sale.

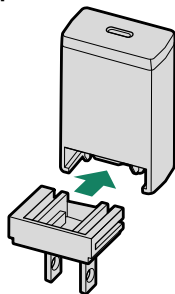

2 Charge the battery.

Connect the camera to the supplied AC power adapter using the supplied USB cable. Then plug the AC power adapter into an indoor power outlet.

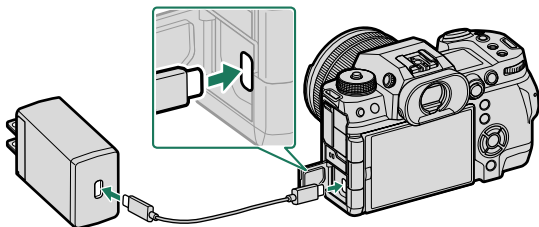

- Connect the cable to the camera's USB connector (Type-C).
- Be sure the connectors are fully inserted.

Charge Status

The indicator lamp shows battery charge status as follows:

Indicator lamp	Battery status
On	Battery charging
Off	Charging complete
Blinks	Charging error

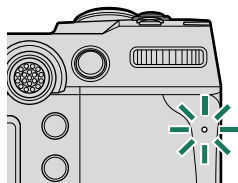

- ❗ • The supplied AC power adapter is compatible with power supplies of 100 to 240 V (a plug adapter may be needed for overseas use).
- Do not use the AC power adapter or USB cable with other devices, as this could cause malfunction.
- Do not affix labels or other objects to the battery. Failure to observe this precaution could make it impossible to remove the battery from the camera.
- Do not short the battery terminals. The battery could overheat.
- Read the cautions in “The Battery and Power Supply”.
- Use only genuine Fujifilm rechargeable batteries designated for use in this camera. Failure to observe this precaution could result in product malfunction.
- Do not remove the labels from the battery or attempt to split or peel the outer casing.
- The battery gradually loses its charge when not in use. Charge the battery one or two days before use.
- If the battery fails to hold a charge, it has reached the end of its charging life and must be replaced.
- Unplug the AC power adapter from the power outlet when it is not in use.
- If the battery is left for long periods without charging, you may find that its quality degrades or that it no longer holds a charge. Charge the battery regularly.
- Remove dirt from the battery terminals with a clean, dry cloth. Failure to observe this precaution could prevent the battery from charging.
- Note that charging times increase at low or high temperatures.
- Selecting **ON** for **Bluetooth/SMARTPHONE SETTING > Bluetooth ON/OFF** in the network/USB settings menu increases the drain on the battery.

- 📄 • If the camera is turned on during charging, charging will end and the USB connection will instead be used to power the camera. The battery level will begin to gradually decline.
- The camera will display a “power supply” icon when powered via USB.

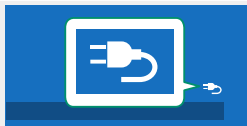

Charging via Computer

The camera can be charged via USB. USB charging is available with computers with a manufacturer-approved operating system and USB interface.

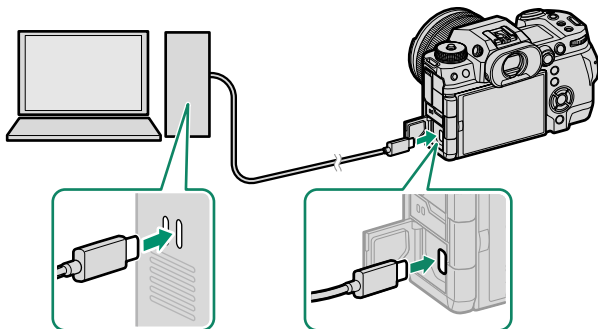

Leave the computer on during charging.

- ❗ The battery will not charge while the camera is on.
- Connect the supplied USB cable.
- Connect the camera directly to the computer; do not use a USB hub or keyboard.
- Charging stops if the computer enters sleep mode. To resume charging, activate the computer and disconnect and reconnect the USB cable.
- Charging may not be supported depending on the model of computer, computer settings, and the computer's current state.
- The battery takes about 600 minutes to charge with a charging input of 5 V/500 mA.

Turning the Camera On and Off

Use the **ON/OFF** switch to turn the camera on and off.

Slide the switch to **ON** to turn the camera on, or to **OFF** to turn the camera off.

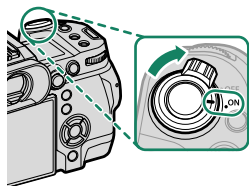

! Fingerprints and other marks on the lens or viewfinder can affect pictures or the view through the viewfinder. Keep the lens and viewfinder clean.

- 📖**
- Pressing the **▶** button during shooting starts playback.
 - Press the shutter button halfway to return to shooting mode.
 - The camera will turn off automatically if no operations are performed for the length of time selected for **▶ POWER MANAGEMENT > AUTO POWER OFF**. To reactivate the camera after it has turned off automatically, press the shutter button halfway or turn the **ON/OFF** switch to **OFF** and then back to **ON**.

Checking the Battery Level

After turning the camera on, check the battery level in the display.

Battery level is shown as follows:

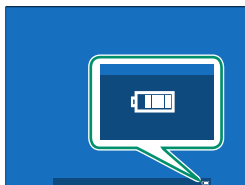

Indicator	Description
	Battery partially discharged.
	Battery about 80% full.
	Battery about 60% full.
	Battery about 40% full.
	Battery about 20% full.
 (red)	Low battery. Charge as soon as possible.
 (blinks red)	Battery exhausted. Turn camera off and recharge battery.

Basic Setup

When you turn the camera on for the first time, you can choose a language and set the camera clock. Follow the steps below when turning the camera on for the first time.

1 Turn the camera on.

A language-selection dialog will be displayed.

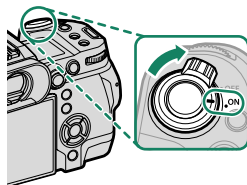

2 Choose a language.

Highlight a language and press **MENU/OK**.

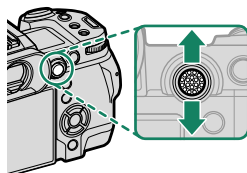

3 Choose a time zone.

When prompted, highlight the current time zone and daylight savings time setting using the focus stick (focus lever) and press **MENU/OK**.

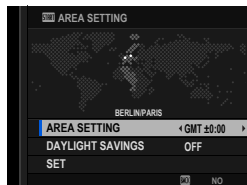

 To skip this step, press **DISP/BACK**.

4 Set the clock.



5 View information on the smartphone app.

- The camera will display a QR code you can scan with your smartphone to open a website where you can download the smartphone app.
- Press **MENU/OK** to exit to the shooting display.

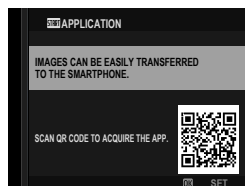

- ☑ Use the smartphone app to download pictures from the camera or control the camera remotely.



6 Format the memory card (📖 246).

- ⚠ Format memory cards before first use, and be sure to reformat all memory cards after using them in a computer or other device.

- ☑ If the battery is removed for an extended period, the camera clock will be reset and the language-selection dialog will be displayed when the camera is turned on.

Choosing a Different Language

To change the language:

- 1 Display language options.**
Select  **USER SETTING** >  **言語/LANG..**
- 2 Choose a language.**
Highlight the desired option and press **MENU/OK**.

Changing the Time and Date

To set the camera clock:

- 1 Display DATE/TIME options.**
Select  **USER SETTING** > **DATE/TIME**.
- 2 Set the clock.**
Press the focus stick (focus lever) left or right to highlight the year, month, day, hour, or minute and press up or down to change. Press **MENU/OK** to set the clock.

Basic Photography and Playback

3

Taking Photographs (Mode P)

This section describes how to take pictures using program AE (mode P). See pages 72–81 for information on S, A, and M modes.

- 1 Rotate the mode dial to P.

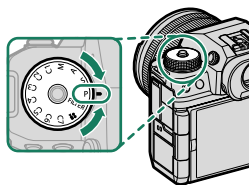

- ! Rotate the mode dial only after pressing the dial lock release to release the dial.

- 2 Confirm that P appears in the display.

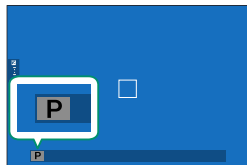

3 Ready the camera.

- Hold the camera steady with both hands and brace your elbows against your sides. Shaking or unsteady hands can blur your shots.

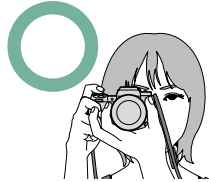

- To prevent pictures that are out of focus or too dark (underexposed), keep your fingers and other objects away from the lens and AF-assist illuminator.

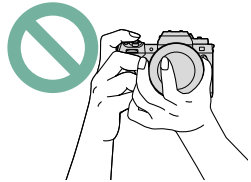

4 Frame the picture.

Lenses with Zoom Rings

Use the zoom ring to frame the picture in the display. Rotate the ring left to zoom out, right to zoom in.



5 Focus.

Press the shutter button halfway to set focus and exposure.

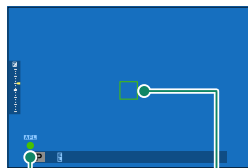

Focus indicator

Focus frame

- **If the camera is able to focus**, the focus frame and focus indicator will glow green.
- **If the camera is unable to focus**, the focus frame will turn red, **!AF** will be displayed, and the focus indicator will blink white.



- If the subject is poorly lit, the AF-assist illuminator may light to assist the focus operation.
- Focus and exposure will lock when the shutter button is pressed halfway. Focus and exposure remain locked while the button is kept in this position (AF/AE lock).
- The camera will focus on subjects at any distance in the macro and standard focus ranges for the lens.

6 Shoot.

Smoothly press the shutter button the rest of the way down to take the picture.



Viewing Pictures

Pictures can be viewed in the viewfinder or LCD monitor.

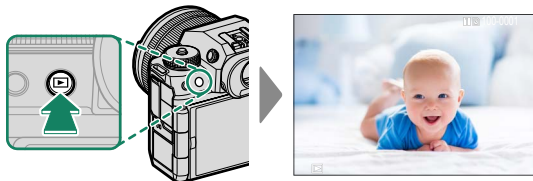

To view pictures full frame, press .



Additional pictures can be viewed by pressing the focus stick (focus lever) left or right or rotating the front command dial. Press the focus stick or rotate the dial right to view pictures in the order recorded, left to view pictures in reverse order. Keep the focus stick pressed to scroll rapidly to the desired frame.

 Pictures taken using other cameras are marked with a  ("gift image") icon to warn that they may not display correctly and that playback zoom may not be available.

Two Memory Cards

If two memory cards are inserted, you can press and hold the  button to choose a card for playback. You can also select a card using the  **PLAY BACK MENU > SWITCH SLOT** option.

HDMI Output

Camera shooting and playback displays can be output to HDMI devices.

Connecting to HDMI Devices

Connect the camera to TVs or other HDMI devices using a third-party HDMI cable.

- 1 Turn the camera off.
- 2 Connect the cable as shown below.

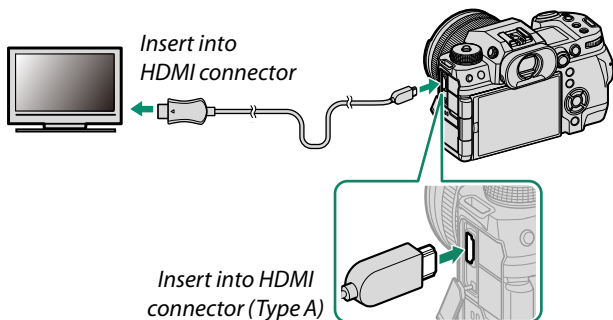

- 3 Configure the device for HDMI input as described in the documentation supplied with the device.
- 4 Turn the camera on. The contents of the camera display will be shown on the HDMI device. The camera display turns off in playback mode (📖 61).

- ❗ • Making sure the connectors are fully inserted.
- Use an HDMI cable no more than 1.5 m (4.9 ft.) long.

Shooting

Display live view or movie footage on a TV or save it to an external recorder that supports HDMI input.

Playback

To start playback, press the camera  button. The camera monitor turns off and pictures and movies are output to the HDMI device. Note that the camera volume controls have no effect on sounds played on the TV; use the television volume controls to adjust the volume.

 Some televisions may briefly display a black screen when movie playback begins.

Deleting Pictures



Use the  button to delete pictures.

 Deleted pictures cannot be recovered. Protect important pictures or copy them to a computer or other storage device before proceeding.

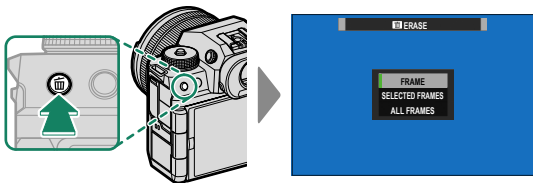
- 1 With a picture displayed full frame, press the  button and select **FRAME**.



- 2 Press the focus stick (focus lever) left or right to scroll through pictures and press **MENU/OK** to delete (a confirmation dialog is not displayed). Repeat to delete additional pictures.

-  Protected pictures cannot be deleted. Remove protection from any pictures you wish to delete (📖 229).
- Pictures can also be deleted from the menus using the  **PLAY BACK MENU > ERASE** option (📖 225).



Movie Recording and Playback

4

Recording Movies

Record movies with sound.

Recording Movies

Movies can be recorded by pressing the  (movie recording) button or rotating the mode dial to  (movie).

The (Movie Recording) Button

Use the  (movie recording) button to quickly and easily record movies while in still photography mode.

 The camera automatically selects **CONTINUOUS AF** for focus mode.

1 Press  to start recording.

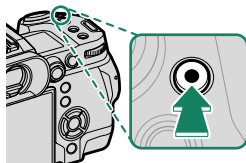

- A recording indicator () is displayed while recording is in progress.
- The time remaining is shown by a countdown display, while another display counts up to show the recording time.

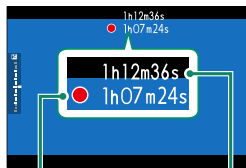

Recording time

Time remaining

2 Press  again to end recording.

Recording ends automatically when the maximum length is reached or the memory card is full.

(Movie) Mode

For more control over camera settings, rotate the mode dial to  (movie) and record movies using the shutter button.

- 1 Rotate the mode dial to  (movie).

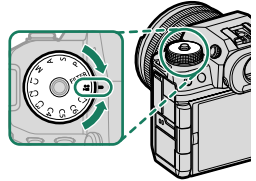

 Rotate the mode dial only after pressing the dial lock release to release the dial.

- 2 Press the shutter button to start recording.

- A recording indicator (●) is displayed while recording is in progress.
- The time remaining is shown by a countdown display, while another display counts up to show the recording time.

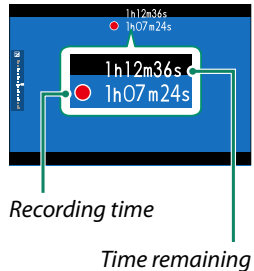

- 3 Press the shutter button again to end recording. Recording ends automatically when the maximum length is reached or the memory card is full.



- Sound is recorded via the built-in microphone or an optional external microphone. Do not cover the microphone during recording.
- Note that the microphone may pick up lens noise and other sounds made by the camera during recording.
- Vertical or horizontal streaks may appear in movies containing very bright subjects. This is normal and does not indicate a malfunction.



- The indicator lamp lights while recording is in progress (the  **MOVIE SETTING > TALLY LIGHT** option can be used to choose the lamp—indicator or AF-assist—that lights during movie recording and whether the lamp blinks or remains steady). During recording, you can change exposure compensation by up to ± 2 EV and adjust zoom using the zoom ring on the lens (if available).
- While recording is in progress, you can:
 - Adjust sensitivity
 - Refocus using any of the following methods:
 - Press the shutter button halfway
 - Press a function button to which **AF-ON** is assigned
 - Use touch screen controls
 - Display a histogram or artificial horizon by pressing the button to which **HISTOGRAM** or **ELECTRONIC LEVEL SWITCH** has been assigned
- Recording may be unavailable at some settings, while in other cases settings may not apply during recording.
- To choose the focus area for movie recording, select  **AF/MF SETTING > FOCUS AREA** and use the focus stick (focus lever) and rear command dial ( 96).

Temperature Warnings

The camera automatically turns off to protect itself when its temperature or the temperature of the battery rises. If a temperature warning is displayed, image noise may increase. Turn the camera off and wait for it to cool before turning it on again.

Using an External Microphone

Sound can be recorded with external microphones that connect using jacks 3.5 mm in diameter; microphones that require plug-in power cannot be used. See the microphone manual for details.

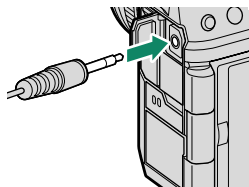





**XLR Microphone Adapters**



The camera can be used with TEAC TASCAM CA-XLR2d-F XLR microphone adapters. For more information, visit the TASCAM website.

https://tascam.jp/int/product/ca-xlr2d/#CA-XLR2d_Website

Adjusting Movie Settings

Movie settings can be adjusted from the movie menus or using the  **MOVIE SETTING** item in the photo menus (📖 28).

- Use the  **MOVIE SETTING** item in the photo menus to quickly adjust settings when recording movies via the  (movie recording) button (📖 180).
- The movie menus contain options for use when recording movies via the shutter button in  (movie) mode (📖 184).
- Settings such as frame rate and frame size can be adjusted using **MOVIE MODE**.
- Use **MEDIA REC SETTING** for such tasks as choosing the file type, bit rate, and the destination card slot.
- Focus mode is selected using  **AF/MF SETTING** >  **FOCUS MODE** in the movie menus. Regardless of the option selected, the camera will automatically switch to **CONTINUOUS AF** when **FACE DETECTION ON** or **SUBJECT DETECTION ON** is chosen for  **AF/MF SETTING** >  **FACE/EYE DETECTION SETTING** or **SUBJECT DETECTION SETTING**. Note, however, that choosing **MANUAL FOCUS** when **FACE DETECTION ON** or **SUBJECT DETECTION ON** is selected disables face and subject detection.

- ! • Changes made using the  **MOVIE SETTING** item in the photo menus also apply to the movie menus. Changes made in one set of menus automatically apply in the other.
- The type of memory card supported varies with the option select for  **MOVIE SETTING** > **MEDIA REC SETTING**.
 - Record ProRes movies to CFexpress cards.
 - Movies with a bit rate of 720 Mbps can be recorded to CFexpress cards or to cards with a Video Speed Class of V90 or better.
 - Movies with a bit rate of 360 Mbps can be recorded to CFexpress cards or to cards with a Video Speed Class of V60 or better.
 - Movies with a bit rate of 100 or 200 Mbps can be recorded to CFexpress cards or to cards with a UHS Speed Class of 3 or better.

Depth of Field

Choose low f-numbers to soften background details. Aperture can be adjusted when the mode dial is set to **A** (aperture-priority AE) or **M** (manual).

Viewing Movies

View movies on the camera.

In full-frame playback, movies are identified by a  icon. Press the focus stick (focus lever) down to start movie playback.

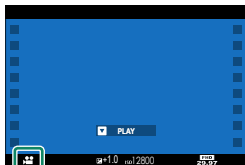

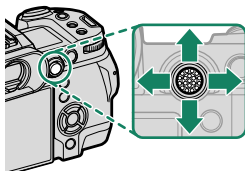

The following operations can be performed while a movie is displayed:

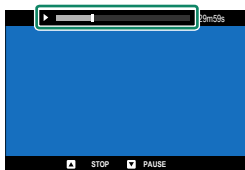

Focus stick (focus lever)	Full-frame playback	Playback in progress (▶)	Playback paused (⏸)
Up	—	End playback	
Down	Start playback	Pause playback	Start/resume playback
Left/right	View other pictures	Adjust speed	Single frame rewind/advance

Progress is shown in the display during playback.



 Do not cover the speaker during playback.

- Press **MENU/OK** to pause playback and display volume controls. Press the focus stick (focus lever) up or down to adjust the volume; press **MENU/OK** again to resume playback. Volume can also be adjusted using **SOUND SET-UP > PLAYBACK VOLUME**.
- To view movies on a television connected via HDMI instead of in the camera monitor, press the  button (60).

Playback Speed

Press the focus stick (focus lever) left or right to adjust playback speed during playback. Speed is shown by the number of arrows (▶ or ◀).



Arrows

Taking Photographs

5

P, S, A, and M Modes

P, S, A, and M modes give you varying degrees of control over shutter speed and aperture.

Mode P: Program AE

Let the camera choose shutter speed and aperture for optimal exposure. Other values that produce the same exposure can be selected with program shift.

Rotate the mode dial to P.

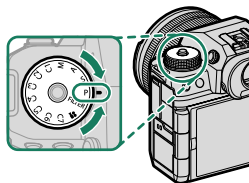

P will appear in the display.

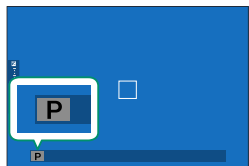

- If the subject is outside the metering range of the camera, the shutter speed and aperture displays will show "-- --".
- Rotate the mode dial only after pressing the dial lock release to release the dial.

Program Shift

If desired, you can rotate the front command dial to select other combinations of shutter speed and aperture without altering exposure (program shift).

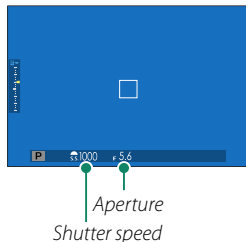

❗ Program shift is not available in any of the following circumstances:

- When **TTL** is selected for **⚡ FLASH SETTING > FLASH FUNCTION SETTING**
- When an auto option is selected for **📷 IMAGE QUALITY SETTING > DYNAMIC RANGE**
- In movie mode

🔌 To cancel program shift, turn the camera off.

Mode S: Shutter-Priority AE

Choose a shutter speed and let the camera adjust aperture for optimal exposure.

- 1 Rotate the mode dial to S.

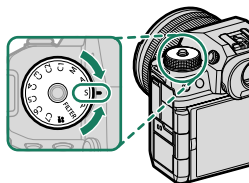

S will appear in the display.

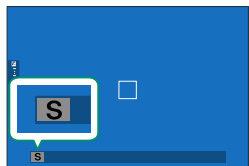

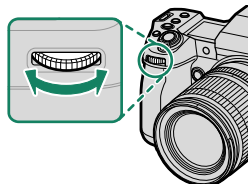

- 2 Rotate the front command dial to choose a shutter speed.



 The roles played by the front command dial can be changed using **FUNCTION/COMMAND DIAL SETTING > COMMAND DIAL SETTING**.

-  If the correct exposure cannot be achieved at the selected shutter speed, aperture will be displayed in red.
- If the subject is outside the metering range of the camera, the aperture display will show “---”.
- Rotate the mode dial only after pressing the dial lock release to release the dial.

-  Shutter speed can be adjusted while the **AFON** button is pressed or the shutter button is pressed halfway.
- At shutter speeds slower than 1 second, a count-down timer will be displayed while the exposure is in progress.
- To reduce “noise” (mottling) in long time-exposures, select **ON** for  **IMAGE QUALITY SETTING > LONG EXPOSURE NR.** Note that this may increase the time needed to record images after shooting.
- The picture will go out of focus if the camera is moved during a long time-exposure; use of a tripod is recommended.

Mode A: Aperture-Priority AE

Choose an aperture and let the camera adjust shutter speed for optimal exposure.

- 1 Rotate the mode dial to A.

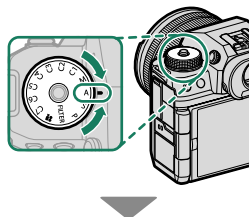

A will appear in the display.

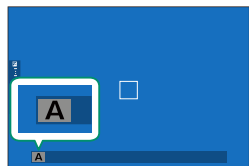

- 2 Rotate the lens aperture ring to choose an aperture.

- If the lens is not equipped with an aperture ring or if the aperture ring is in the **A** position, aperture can be adjusted by rotating the front command dial.
- The roles played by the front command dial can be changed using **FUNCTION/SETTING > COMMAND DIAL SETTING**.

- ! If the correct exposure cannot be achieved at the selected aperture, shutter speed will be displayed in red.
- If the subject is outside the metering range of the camera, the shutter speed display will show "-- --".
- Rotate the mode dial only after pressing the dial lock release to release the dial.

- Aperture can be adjusted even while the shutter button is pressed halfway.

Previewing Depth of Field

When **PREVIEW DEPTH OF FIELD** is assigned to a function button, pressing the button displays a  icon and stops aperture down to the selected setting, allowing depth of field to be previewed in the display.

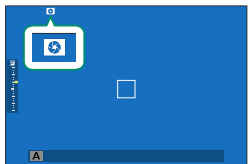

Mode M: Manual Exposure

In manual mode, the user controls both shutter speed and aperture. Shots can be deliberately overexposed (brighter) or underexposed (darker), opening the door for a variety of individual creative expression. The amount the picture would be under- or over-exposed at current settings is shown by the exposure indicator; adjust shutter speed and aperture until the desired exposure is reached.

- 1 Rotate the mode dial to M.

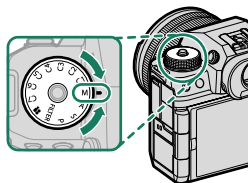

M will appear in the display.

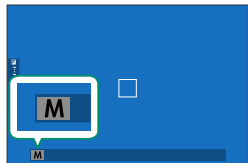

- 2 Rotate the front command dial to choose a shutter speed and the lens aperture ring to choose an aperture.

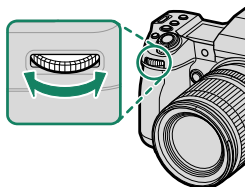

- The manual exposure display includes an exposure indicator that shows the amount the picture would be under- or over-exposed at current settings.
- If the lens is not equipped with an aperture ring or if the aperture ring is in the **A** position, aperture can be adjusted by rotating the rear command dial.
- The roles played by the front and rear command dials can be changed using **☑ BUTTON/DIAL SETTING > COMMAND DIAL SETTING**.

- ! Rotate the mode dial only after pressing the dial lock release to release the dial.



BULB

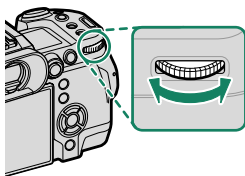

Select a shutter speed of **BULB** for long time-exposures in which you open and close the shutter manually. Use of a tripod is recommended to prevent the camera moving during the exposure.

- 1 Set shutter speed to **BULB**.



- 2 Press the shutter button all the way down.
- The shutter will remain open for up to 60 minutes while the shutter button is pressed.
 - The display shows the time elapsed since the exposure started.
 - Releasing the shutter button closes the shutter, ending the exposure. Processing will begin, and the camera will display the processing time remaining.

 Bulb photography is not available in drive modes other than **STILL IMAGE** or when the electronic shutter is selected for  **SHOOTING SETTING > SHUTTER TYPE**.

-  • Selecting an aperture of **A** fixes shutter speed at 30 s.
- To reduce “noise” (mottling) in long time-exposures, select **ON** for  **IMAGE QUALITY SETTING > LONG EXPOSURE NR**. Note that this may increase the time needed to record images after shooting.

Using a Remote Release

A remote release can be used for long time-exposures. When using an optional RR-100 remote release or an electronic release from third-party suppliers, connect it to the camera's remote release connector.

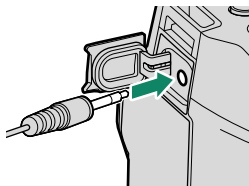

Exposure Preview

To preview exposure in the LCD monitor, select **PREVIEW EXP./WB** for **SCREEN SET-UP > PREVIEW EXP./WB IN MANUAL MODE**.



Select an option other than **PREVIEW EXP./WB** when using the flash or on other occasions on which exposure may change when the picture is taken.

FILTER

Take photos with filter effects.

- 1 Rotate the mode dial to **FILTER**.

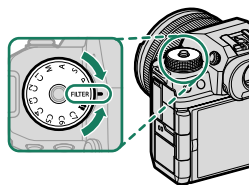

- 2 Choose a filter via **SHOOTING SETTING > FILTER SETTING**.

Filter	Description
TOY CAMERA	Choose for a retro toy camera effect.
MINIATURE	The tops and bottoms of pictures are blurred for a diorama effect.
POP COLOR	Create high-contrast images with saturated colors.
HIGH-KEY	Create bright, low-contrast images.
LOW-KEY	Create uniformly dark tones with few areas of emphasized highlights.
DYNAMIC TONE	Dynamic tone expression is used for a fantasy effect.
SOFT FOCUS	Create a look that is evenly soft throughout the whole image.
PARTIAL COLOR (RED)	Areas of the image that are the selected color are recorded in that color. All other areas of the image are recorded in black-and-white.
PARTIAL COLOR (ORANGE)	
PARTIAL COLOR (YELLOW)	
PARTIAL COLOR (GREEN)	
PARTIAL COLOR (BLUE)	
PARTIAL COLOR (PURPLE)	

Depending on the subject and camera settings, images may in some cases be grainy or vary in brightness or hue.

Custom Modes

Rotate the mode dial to any of modes **C1 (CUSTOM 1)** through **C7 (CUSTOM 7)** to take pictures using previously-saved shooting menu settings.

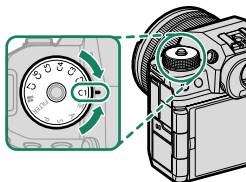

Mode Selection: Still Photography or Movie

Choose whether the selected custom settings bank (**C1** through **C7**) is for still photography (**📷 STILL**) or movie recording (**🎥 MOVIE**).

- 1 Navigate to **📷 IMAGE QUALITY SETTING** in the photo menus, highlight **📷🎥 CUSTOM MODE SETTING**, and press **MENU/OK**.

📷 You can also use **🎥 MOVIE SETTING > 📷🎥 CUSTOM MODE SETTING** in the movie menus.

- 2 Highlight the desired custom settings bank and press **MENU/OK**.

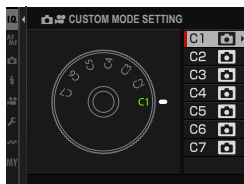

- 3 Highlight **📷 STILL** or **🎥 MOVIE** and press **MENU/OK**.

The selected custom settings bank can now be used for still photography or movie recording.



Saving Current Settings

Save current settings in a custom settings bank.

- 1 Navigate to **IMAGE QUALITY SETTING** in the photo menus, highlight **EDIT/SAVE CUSTOM SETTING**, and press **MENU/OK**.

 To save settings for movie recording, navigate to **MOVIE SETTING** in the movie menus and select **EDIT/SAVE CUSTOM SETTING**.

- 2 Highlight a destination bank for current settings (C1 through C7) and press **MENU/OK**.

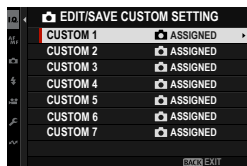

- 3 Highlight **SAVE CURRENT SETTINGS** and press **MENU/OK**.

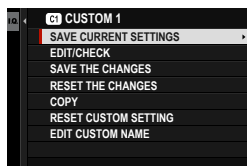

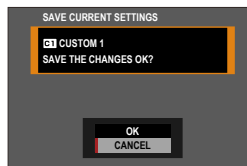

- 4 Highlight **OK** and press **MENU/OK**. Current settings will be saved to the selected bank.



Editing Custom Settings

Edit existing custom settings banks.

- 1 Navigate to  **IMAGE QUALITY SETTING** in the photo menus, highlight  **EDIT/SAVE CUSTOM SETTING**, and press **MENU/OK**.

 To save settings for movie recording, navigate to  **MOVIE SETTING** in the movie menus and select  **EDIT/SAVE CUSTOM SETTING**.

- 2 Highlight the desired custom settings bank and press **MENU/OK**.

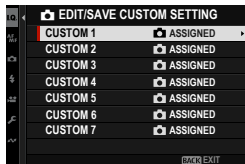

- 3 Highlight **EDIT/CHECK** and press **MENU/OK**.

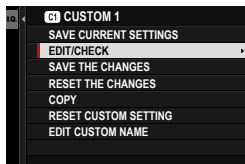

- 4 The camera will display a list of shooting menu items; highlight an item you wish to edit and press **MENU/OK**. Adjust the selected item as desired.

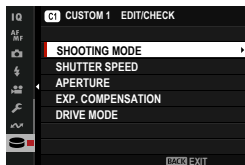

5 Press **MENU/OK** to save the changes and return to the shooting menu list.

Adjust additional items as desired.



If **DISABLE** is selected for **IMAGE QUALITY SETTING > AUTO UPDATE CUSTOM SETTING** in the photo menu or for **MOVIE SETTING > AUTO UPDATE CUSTOM SETTING** in the movie menu, red dots will appear next to the edited items but the changes will not be saved automatically.

- To save the changes for selected items, highlight the items in the list and press **Q**.
- To save changes for all items, return to Step 3 and select **SAVE THE CHANGES**. To cancel all changes and restore the previous settings, select **RESET THE CHANGES**.
- If you copy an item marked by a red dot, the item will be copied with the changes intact.

Copying Custom Settings

Copy custom settings from one bank to another, overwriting the settings in the destination bank. If the source bank has been re-named, the name will also be copied to the destination bank.

- 1 Navigate to **IMAGE QUALITY SETTING** in the photo menus, highlight **EDIT/SAVE CUSTOM SETTING**, and press **MENU/OK**.

 To copy settings for a movie custom settings bank, navigate to **MOVIE SETTING** in the movie menus and select **EDIT/SAVE CUSTOM SETTING**.

- 2 Highlight the source bank and press **MENU/OK**.

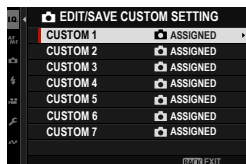

- 3 Highlight **COPY** and press **MENU/OK**.

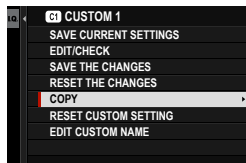

- 4 Highlight the destination bank (C1 through C7) and press **MENU/OK**. A confirmation dialog will be displayed.

 Any changes to custom settings in the destination bank will be overwritten.

- 5 Highlight **OK** and press **MENU/OK**. The selected settings will be copied to the destination bank, overwriting any existing settings.

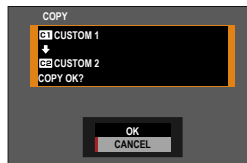
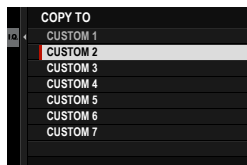

Resetting Custom Settings

Reset selected custom settings banks.

- 1 Select **IMAGE QUALITY SETTING** > **EDIT/SAVE CUSTOM SETTING** in the shooting menu and press **MENU/OK**.

 This assumes that you wish to reset settings for still photography. To reset movie settings, navigate to **MOVIE SETTING** in the movie menus and select **EDIT/SAVE CUSTOM SETTING**.

- 2 Highlight the desired custom settings bank and press **MENU/OK**.

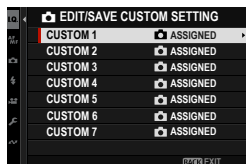

- 3 Highlight **RESET CUSTOM SETTING** and press **MENU/OK**.
A confirmation dialog will be displayed.

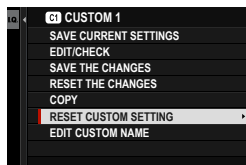

- 4 Highlight **OK** and press **MENU/OK**.
The selected bank will be reset.

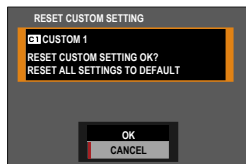

Renaming Custom Settings Banks

Rename selected custom settings banks.

- 1 Select **IMAGE QUALITY SETTING** > **EDIT/SAVE CUSTOM SETTING** in the shooting menu and press **MENU/OK**.

 This assumes that you wish to rename settings for still photography. To rename movie settings, navigate to **MOVIE SETTING** in the movie menus and select **EDIT/SAVE CUSTOM SETTING**.

- 2 Highlight the desired custom settings bank and press **MENU/OK**.

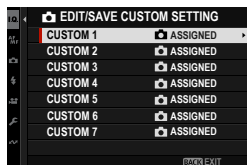

- 3 Highlight **EDIT CUSTOM NAME** and press **MENU/OK**.

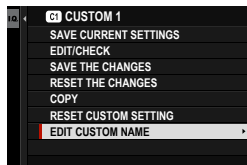

- 4 Enter a new name for the custom settings bank and select **SET**.
The selected bank will be renamed.

Autofocus

Take pictures using autofocus.

- 1 Select single or continuous AF for **AF/MF SETTING** > **FOCUS MODE** in the shooting menu (📖 92).
- 2 Use **AF/MF SETTING** > **AF MODE** to choose an AF mode (📖 94).
- 3 Select **AF/MF SETTING** > **FOCUS AREA** and choose the position and size of the focus frame (📖 96).

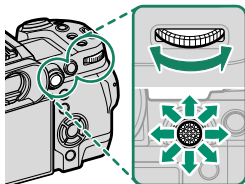





- 4 Take pictures.

Focus Mode

Choose how the camera focuses.

- 1 Press **MENU/OK** to display the menus.
- 2 Select  **AF/MF SETTING** > **FOCUS MODE** in the shooting menu.
- 3 Choose from the following options:

Mode	Description
 MANUAL FOCUS	Focus manually using the lens focus ring. Choose for manual control of focus or in situations in which the camera is unable to focus using autofocus (📖 100).
 CONTINUOUS AF	Focus is continually adjusted to reflect changes in the distance to the subject while the shutter button is pressed halfway. Use for subjects that are in motion.
 SINGLE AF	Focus locks while the shutter button is pressed halfway. Choose for stationary subjects.

- Regardless of the option selected, manual focus will be used when the lens is in manual focus mode.
- If **ON** is selected for  **AF/MF SETTING** > **PRE-AF**, focus will be adjusted continuously in modes  and  even when the shutter button is not pressed.

The Focus Indicator

Focus status is shown by the focus indicator.

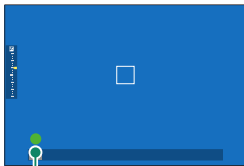

Focus indicator

Focus indicator	Focus status
()	Camera focusing.
● (lights green)	Subject in focus; focus locked (focus mode AF-L).
● (lights green)	Subject in focus (focus mode AF-A). Focus is automatically adjusted for changes in distance to subject.
○ (blinks white)	Camera unable to focus.
MF	Manual focus (focus mode MF).









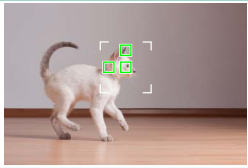

Autofocus Options (AF Mode)

Focus can be adapted to a variety of subjects by changing the combination of settings selected for focus and AF modes.









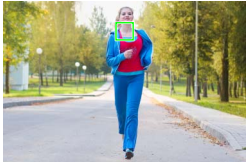

- 1 Press **MENU/OK** and go to the shooting menu.
- 2 Select **AF/MF SETTING > AF MODE**.
- 3 Choose an AF mode.

How the camera focuses depends on the focus mode.

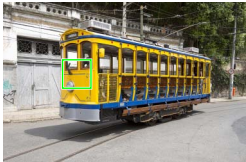
Focus Mode (SINGLE AF)

Option	Description	Sample image
 SINGLE POINT	Camera focuses on subject in selected focus point. Use for pin-point focus on selected subject.	
 ZONE	Camera focuses on subject in selected focus zone. Focus zones include multiple focus points, making it easier to focus on subjects in motion.	
 WIDE	Camera focuses automatically on high-contrast subjects; display shows areas in focus.	
 ALL	Rotate the rear command dial in the focus-point selection display ( 97, 98) to cycle through AF modes in the following order:  SINGLE POINT ,  ZONE , and  WIDE .	

Focus Mode  (CONTINUOUS AF)

Option	Description	Sample image
 SINGLE POINT	Focus tracks subject at selected focus point. Use for subjects moving toward or away from camera.	
 ZONE	Camera tracks focus in selected focus zone. Use for subjects that are moving fairly predictably.	
 TRACKING	Focus tracks subjects moving through wide area of frame.	
 ALL	Rotate the rear command dial in the focus-point selection display ( 97, 98) to cycle through AF modes in the following order:  SINGLE POINT ,  ZONE , and  TRACKING .	

Focus-Point Selection

Choose a focus point for autofocus.

Viewing the Focus-Point Display







- 1 Press **MENU/OK** and go to the shooting menu.
- 2 Select  **AF/MF SETTING** > **FOCUS AREA** to view the focus-point display.
- 3 Use the focus stick (focus lever) and rear command dial to choose a focus area.

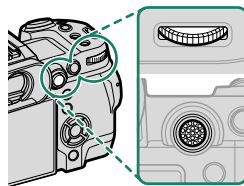







 The focus point can also be selected using touch controls (📖 31).

Selecting a Focus Point

Use the focus stick (focus lever) to choose the focus point and the rear command dial to choose the size of the focus frame. The procedure varies with the option selected for AF mode.







AF mode	Focus stick		Rear command dial	DISP/BACK button
	 Tilt	 Press	 Rotate	
	Select focus point	Select highlighted focus point	Choose from 6 frame sizes	Select center focus point
			Choose from 3 frame sizes	
			—	

- Manual focus-point selection is not available when  **WIDE/TRACKING** is selected in focus mode .
- If  **ALL** is selected for AF mode, you can rotate the rear command dial in the focus-point selection display to cycle through AF modes in the following order:  **SINGLE POINT** (6 frame sizes),  **ZONE** (3 frame sizes), and either  **WIDE** (focus mode ) or  **TRACKING** (focus mode .

The Focus-Point Display

The focus-point display varies with the option selected for AF mode.

 Focus frames are shown by small squares (□), focus zones by the large squares.

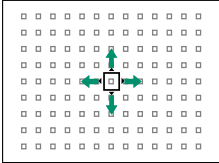
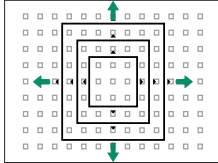
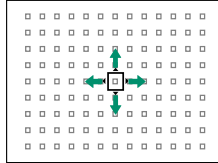
AF mode		
 SINGLE POINT	 ZONE	 WIDE/TRACKING
		
Number of points available can be selected using AF/MF SETTING > NUMBER OF FOCUS POINTS.	Choose from zones with 7×7 , 5×5 , or 3×3 focus points.	Position focus frame over subject you want to track using continuous AF.

Autofocus

Although the camera boasts a high-precision autofocus system, it may be unable to focus on the subjects listed below.

- Very shiny subjects such as mirrors or car bodies.
- Subjects photographed through a window or other reflective object.
- Dark subjects and subjects that absorb rather than reflect light, such as hair or fur.
- Insubstantial subjects, such as smoke or flame.
- Subjects that show little contrast with the background.
- Subjects positioned in front of or behind a high-contrast object that is also in the focus frame (for example, a subject photographed against a backdrop of highly contrasting elements).

Checking Focus

To zoom in on the current focus area for precise focus, press the center of the focus stick (focus lever). Press up to two times more to zoom in further and a fourth time to cancel zoom.

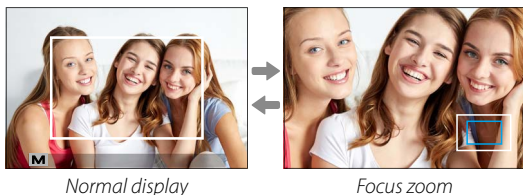
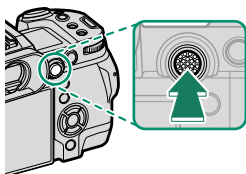

Normal display

Focus zoom



- In focus mode **[AF-S]**, zoom can be adjusted by rotating the rear command dial.
- In focus mode **[AF-S]**, select **SINGLE POINT** for **AF MODE**.
- Focus zoom is not available in focus mode **[AF-C]** or when **[AF/MF]** **SETTING > PRE-AF** is on.
- Use **[Z]** **BUTTON/DIAL SETTING > FOCUS LEVER SETTING** to change the function performed by the center of the focus stick (focus lever). **[Z]** **BUTTON/DIAL SETTING > FUNCTION (Fn) SETTING** can also be used to assign focus zoom to other controls.

Manual Focus

Adjust focus manually.

- 1 Select **MANUAL FOCUS** for **AF/MF SETTING > FOCUS MODE**.

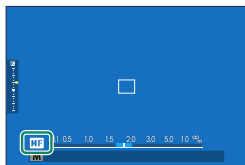

- 2 Focus manually using the lens focus ring. Rotate the ring left to reduce the focus distance, right to increase.

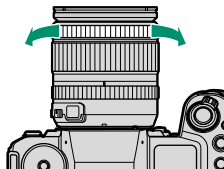

- 3 Take pictures.



- Use **FUNCTION/DIAL SETTING > LENS ZOOM/FOCUS SETTING** to reverse the direction of rotation of the focus ring.
- Regardless of the option selected, manual focus will be used when the lens is in manual focus mode.

Quick Focus

- To use autofocus to focus on the subject in the selected focus area, press the button to which focus lock or **AF-ON** has been assigned (the size of the focus area can be chosen with the rear command dial).
- In manual focus mode, you can use this feature to quickly focus on a chosen subject using either single or continuous AF according to the option chosen for  **AF/MF SETTING > INSTANT AF SETTING**.

Checking Focus

A variety of options are available for checking focus in manual focus mode.

The Manual Focus Indicator

The white line indicates the distance to the subject in the focus area (in meters or feet according to the option selected for **SCREEN SET-UP > FOCUS SCALE UNITS** in the setup menu), the blue bar the depth of field, or in other words the distance in front of and behind the subject that appears to be in focus.

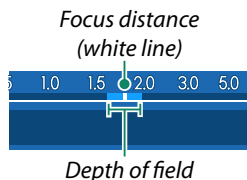

- If both **AF DISTANCE INDICATOR** and **MF DISTANCE INDICATOR** are selected in the **SCREEN SET-UP > DISP. CUSTOM SETTING** list, the manual focus indicator can also be viewed using the depth-of-field indicator in the standard display. Use the **DISP/BACK** button to display standard indicators.
- Use the **AF/MF SETTING > DEPTH-OF-FIELD SCALE** option to choose how depth of field is displayed. Choose **FILM FORMAT BASIS** to help you make practical assessments of depth of field for pictures that will be viewed as prints and the like, **PIXEL BASIS** to help you assess depth of field for pictures that will be viewed at high resolutions on computers or other electronic displays.

Focus Zoom

If **ON** is selected for **AF/MF SETTING > FOCUS CHECK**, the camera will automatically zoom in on the selected focus area when the focus ring is rotated. Press the center of the focus stick (focus lever) to exit zoom.

- Use the focus stick (focus lever) to choose another focus area.
- Zoom can be adjusted by rotating the rear command dial. Zoom cannot, however, be adjusted when **DIGITAL SPLIT IMAGE** or **DIGITAL MICROPRISM** is selected for MF assist.

MF Assist

Use **AF/MF SETTING > MF ASSIST** (📖 160) in the photo menus or **AF/MF SETTING > MF ASSIST** (📖 206) in the movie menus to choose a focus check option.

- The focus check options for movies differ from those for still photography.

- **DIGITAL SPLIT IMAGE:** Displays a split image in the center of the frame. Frame the subject in the split-image area and rotate the focus ring until the four parts of the split image are correctly aligned.
- **DIGITAL MICROPRISM:** A grid pattern that emphasizes blur is displayed when the subject is out of focus, disappearing to be replaced by a sharp image when the subject is in focus.

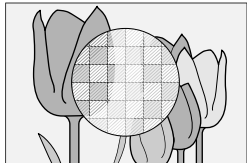
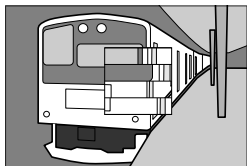

- **FOCUS PEAK HIGHLIGHT:** Highlights high-contrast outlines. Rotate the focus ring until the subject is highlighted.



- **FOCUS METER:** A meter is displayed below the focus point indicating whether focus is in front of or behind the subject. The needle swings left when focus is in front of the subject and right when it is behind the subject. Adjust focus so the needle is pointing straight up.



 The display reverses when  **CCW** is selected for  **BUTTON/DIAL SETTING > LENS ZOOM/FOCUS SETTING > FOCUS RING ROTATE.**

Sensitivity

Adjust the camera's sensitivity to light.

To view sensitivity settings, press the **ISO** button.

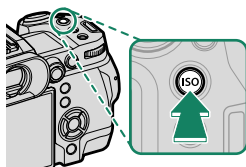

Option	Description
AUTO1 AUTO2 AUTO3	Sensitivity is automatically adjusted in response to shooting conditions according to combination of standard and maximum sensitivity and minimum shutter speed chosen for SHOOTING SETTING > ISO . Choose from AUTO1 , AUTO2 , and AUTO3 (106).
125–12800	Adjust sensitivity manually. Selected value is shown in display.
L (64/80/100) H (25600/51200)	Choose for special situations. Note that mottling may appear in pictures taken at H , while L reduces dynamic range.

 Sensitivity is not reset when the camera is turned off.

Adjusting Sensitivity

High values can be used to reduce blur when lighting is poor, while lower values allow slower shutter speeds or wider apertures in bright light; note, however, that mottling may appear in pictures taken at high sensitivities.

AUTO

Choose the base sensitivity, maximum sensitivity, and minimum shutter speed for **AUTO1**, **AUTO2**, and **AUTO3**.

Item	Options	Default		
		AUTO1	AUTO2	AUTO3
DEFAULT SENSITIVITY	125–12800	125		
MAX. SENSITIVITY	400–12800	800	3200	12800
MIN. SHUTTER SPEED	1/500–1/4 SEC, AUTO	AUTO		

The camera automatically chooses a sensitivity between the default and maximum values; sensitivity is only raised above the default value if the shutter speed required for optimal exposure would be slower than the value selected for **MIN. SHUTTER SPEED**.







- If the value selected for **DEFAULT SENSITIVITY** is higher than that selected for **MAX. SENSITIVITY**, **DEFAULT SENSITIVITY** will be set to the value selected for **MAX. SENSITIVITY**.
- The camera may select shutter speeds slower than **MIN. SHUTTER SPEED** if pictures would still be underexposed at the value selected for **MAX. SENSITIVITY**.
- If **AUTO** is selected for **MIN. SHUTTER SPEED**, the camera will automatically adjust the minimum shutter speed according to the focal length of the lens (the setting remains the same whether image stabilization is on or off).

Metering

Choose how the camera meters exposure.

SHOOTING SETTING > PHOTOMETRY offers a choice of the following metering options:

 The selected option will only take effect if **OFF** is selected for **FACE/EYE DETECTION SETTING** and **SUBJECT DETECTION SETTING** in the **AF/MF SETTING** menu.

Mode	Description
 MULTI	The camera instantly determines exposure based on an analysis of composition, color, and brightness distribution. Recommended in most situations.
 CENTER-WEIGHTED	The camera meters the entire frame but assigns the greatest weight to the area at the center.
 SPOT	The camera meters lighting conditions in an area equivalent to 2% of the frame. Recommended with backlit subjects and in other cases in which the background is much brighter or darker than the main subject.
 AVERAGE	Exposure is set to the average for the entire frame. Provides consistent exposure across multiple shots with the same lighting, and is particularly effective for landscapes and portraits of subjects dressed in black or white.

 To meter the subject in the selected focus area, choose **ON** for **AF/MF SETTING > INTERLOCK SPOT AE & FOCUS AREA** (📖 161).

Exposure Compensation

Adjust exposure.

Rotate the rear command dial to adjust exposure.

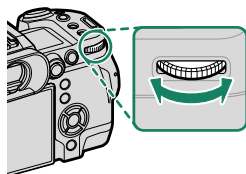

- The command dial used in this role can be chosen using **FUNCTION/COMMAND DIAL SETTING > COMMAND DIAL SETTING**.
- In manual mode, exposure can be adjusted by rotating the front or rear command dial after pressing a control to which **WHEN SET TO M (ON/OFF SWITCH)** is assigned.

- The amount of compensation available varies with the shooting mode.
- Exposure compensation can be previewed in the shooting display, although the display may not accurately reflect its effects if:
 - the exposure compensation amount exceeds ± 3 EV,
 - **200 200%** or **400 400%** is selected for **DYNAMIC RANGE**, or
 - **STRONG** or **WEAK** is selected for **D RANGE PRIORITY**.

Exposure compensation can still be previewed in the viewfinder or LCD monitor by pressing the shutter button halfway. In movie mode, the display may not accurately reflect the effects of exposure compensation during F-log recording or when **200 200%** or **400 400%** is selected for **DYNAMIC RANGE**. An accurate preview can be obtained by selecting mode **M** and adjusting exposure directly.

Focus/Exposure Lock

Focus and exposure lock when the shutter button is pressed halfway.

- 1 Position the subject in the focus frame and press the shutter button halfway to lock focus and exposure. Focus and exposure will remain locked while the shutter button is pressed halfway (AF/AE lock).

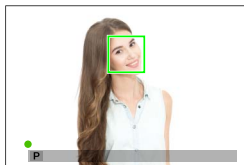

- 2 Press the button all the way down.

 Focus and exposure lock via the shutter button is only available when **ON** is selected for **FUNCTION BUTTON/DIAL SETTING > SHUTTER AF, SHUTTER AE**.

Other Controls

Focus and exposure can also be locked using the **AEL** and **AFON** buttons. At default settings, you can use the **AEL** button to lock exposure without locking focus. If the **AFON** button is assigned **AF LOCK ONLY**, it can similarly be used to lock focus without locking exposure.

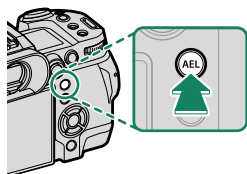

AEL button
(exposure lock)

- While the assigned control is pressed, pressing the shutter button halfway will not end the lock.
- If **AE&AF ON/OFF SWITCH** is selected for **☑️ BUTTON/DIAL SETTING > AE/AF-LOCK MODE**, the lock can only be ended by pressing the control a second time.

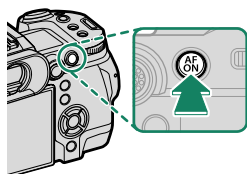

AFON button

- ☑️ • The focus lever (focus stick) can be used to reposition the focus point during exposure lock.
- The **AEL** and **AFON** buttons can be assigned other roles using **☑️ BUTTON/DIAL SETTING > FUNCTION (Fn) SETTING**. Exposure and focus lock can also be assigned to other buttons (📖 300).

Continuous Shooting (Burst Mode)

Capture motion in a series of pictures.

- 1 Press the **DRIVE** button to display drive mode options.

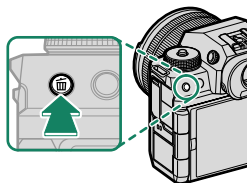



- 2 If **CH HIGH SPEED BURST** or **CL LOW SPEED BURST** is selected, the camera will take pictures continuously while the shutter-release button is pressed.

Shooting ends when the shutter button is released or the memory card is full.

- ! If file numbering reaches 9999 before shooting is complete, the remaining pictures will be recorded to a new folder.
- Shooting ends when the memory card is full; the camera will record all photos shot to that point. Burst shooting may not begin if the space available on the memory card is insufficient.
- Frame rates may slow as more shots are taken.
- Frame rate varies with the scene, shutter speed, sensitivity, and focus mode.
- Depending on shooting conditions, frame rates may slow or the flash may not fire.
- Recording times may increase during burst shooting.
- The choice of burst modes varies with the option selected for **SHOOTING SETTING > SHUTTER TYPE**.

Focus and Exposure

- Select focus mode **CONTINUOUS AF** to vary focus with shot.
- To vary exposure with each shot, select **OFF** for  **BUTTON/DIAL SETTING > SHUTTER AE.**

 Depending on such factors as aperture, sensitivity, and exposure compensation, exposure may not be adjusted automatically.

Bracketing

Automatically vary settings over a series of pictures.

- 1 Press the **DRIVE** button to display drive mode options.

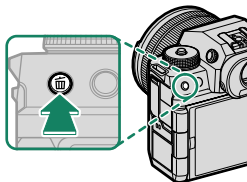

- 2 Press the focus stick (focus lever) up or down to highlight one of the following:

Option		Option	
ISO ISO BKT	114	BKT Bracketing	115
WB WHITE BALANCE BKT	114		

- 3 Press the focus stick left or right to highlight the desired bracketing settings.
- 4 Press **MENU/OK** to select.
- 5 Take pictures.

ISO ISO BKT

Select a bracketing amount ($\pm\frac{1}{3}$, $\pm\frac{2}{3}$, or ± 1) in the drive mode display. Each time the shutter is released, the camera will take a picture at the current sensitivity and process it to create two additional copies, one with sensitivity raised and the other with sensitivity lowered by the selected amount.

WB WHITE BALANCE BKT

Select a bracketing amount (± 1 , ± 2 , or ± 3) in the drive mode display. Each time the shutter is released, the camera takes one shot and processes it to create three copies: one at the current white balanced setting, one with fine-tuning increased by the selected amount, and another with fine-tuning decreased by the selected amount.

BKT Bracketing

AE BKT

Use  **SHOOTING SETTING > AE BKT SETTING** to choose the bracketing amount, bracketing order, and number of shots. The camera will take the specified number of shots in sequence: one using the metered value for exposure and the others over- or under-exposed by multiples of the selected bracketing amount.

 Regardless of the bracketing amount, exposure will not exceed the limits of the exposure metering system.

FILM SIMULATION BKT

Each time the shutter is released, the camera takes one shot and processes it to create copies with different film simulation settings, chosen using  **SHOOTING SETTING > FILM SIMULATION BKT**.

DYNAMIC RANGE BKT

Each time the shutter button is pressed, the camera takes three shots with different dynamic ranges: 100% for the first, 200% for the second, and 400% for the third.

 While dynamic range bracketing is in effect, sensitivity will be restricted to a minimum of ISO 500; the sensitivity previously in effect is restored when bracketing ends.

FOCUS BKT

Each time the shutter button is pressed, the camera takes a series of photos, varying focus with each shot. The **SHOOTING SETTING > FOCUS BKT SETTING** item offers a choice of **MANUAL** and **AUTO** bracketing.

- Do not adjust zoom during shooting.
- Use of a tripod is recommended.

MANUAL

In **MANUAL** mode, you choose the following.

Option	Description
FRAMES	Choose the number of shots.
STEP	Choose the amount focus changes with each shot.
INTERVAL	Choose the interval between shots.

Focus and FRAMES/STEP

The relation between focus and the options chosen for **FRAMES** and **STEP** is shown in the illustration.

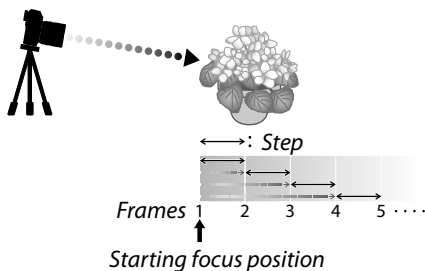



- Focus proceeds from the starting position toward infinity.
- Small **STEP** values translate to small changes in focus, larger values to larger changes.
- Regardless of the option chosen for **FRAMES**, shooting ends when focus reaches infinity.

AUTO

In **AUTO** mode, the camera calculates **FRAMES** and **STEP** automatically.

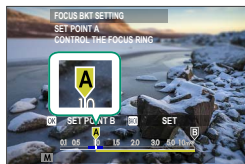
- 1 Select **SHOOTING SETTING** in the shooting menu, highlight **FOCUS BKT SETTING**, and press **MENU/OK**.
- 2 Select **AUTO** and choose an **INTERVAL**.
The view through the lens will be displayed.
- 3 Focus on the nearest end of the subject and press **MENU/OK**.
The selected focus distance appears as **A** on the focus distance indicator.



 The same focus range can be chosen by focusing on the farthest end of the subject first.

- 4 Focus on the farthest end of the subject and press **DISP/BACK**.
The selected focus distance (**B**) and focus range (**A to B**) appear on the focus distance indicator.

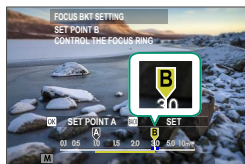

 Instead of pressing the **DISP/BACK** button, you can press **MENU/OK** and select **A** again.

- 5 Take photographs.
The camera will calculate values for **FRAMES** and **STEP** automatically. The number of frames will appear in the display.



HDR

Each time the shutter button is pressed, the camera takes three shots, varying exposure each time, and combines them into a single picture. The resulting photograph preserves details in highlights and shadows.

- 1 Press the **DRIVE** button to display drive mode options and select **HDR**.

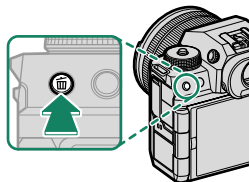



- 2 Choose the amount the brightnesses of the exposures vary.

Option	Description
HDR AUTO	Dynamic range is automatically set to a value of from 200% to 800%.
HDR200	Dynamic range is set to 200%.
HDR400	Dynamic range is set to 400%.
HDR800	Dynamic range is set to 800%.
HDR800+	Camera settings are adjusted for maximum variation in dynamic range.

- 3 Take photographs.
The camera will create a combined image.

-  Keep the camera steady.
- The desired results may not be achieved if the subject moves or the composition or lighting changes during shooting.
- The picture will be cropped a very small amount and the resolution will drop slightly.
- Mottling may appear in pictures taken at higher values. Choose a value according to the scene.
- "Extended" sensitivity values are not supported.
- Depending on the options selected for HDR and sensitivity, pictures may not be taken at the selected shutter speed.
- The flash does not fire.

 HDR images are indicated by a  icon during playback.

Panoramas

Follow an on-screen guide to create a panorama.

- 1 Press the **DRIVE** button to display drive mode options and select **PANORAMA**.

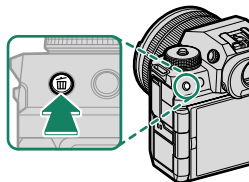

- 2 To select the size of the angle through which you will pan the camera while shooting, press the focus stick (focus lever) left. Highlight a size and press **MENU/OK**.
- 3 Press the focus stick right to view a choice of pan directions. Highlight a pan direction and press **MENU/OK**.
- 4 Press the shutter button all the way down to start recording. There is no need to keep the shutter button pressed during recording.

- 5 Pan the camera in the direction shown by the arrow. Shooting ends automatically when the camera is panned to the end of the guides and the panorama is complete.

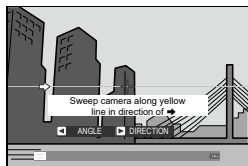

For Best Results

- Move the camera slowly in a small circle at a steady speed
- Keep the camera parallel or at right angles to the horizon and be sure to pan only in the direction shown by the guides
- Try panning at a different speed if the desired results are not achieved
- Prop your elbows against your sides
- Use a tripod
- For best results, use a lens with a focal length of 35 mm or less (50 mm or less in 35 mm format).

- ❗ If the shutter button is pressed all the way down before the panorama is complete, shooting will end and no panorama may be recorded.
- The last part of the panorama may not be recorded if shooting ends before the panorama is complete.
- Panoramas are created from multiple frames, and the camera may in some cases be unable to stitch the frames together perfectly.
- Panoramas may be blurred if the subject is poorly lit.
- Shooting may be interrupted if the camera is panned too quickly or too slowly. Panning the camera in a direction other than that shown cancels shooting.
- The camera may in some cases record a greater or lesser angle than selected.
- The desired results may not be achieved with:
 - Moving subjects
 - Subjects close to the camera
 - Unvarying subjects such as the sky or a field of grass
 - Subjects that are in constant motion, such as waves and waterfalls
 - Subjects that undergo marked changes in brightness
- If **ON** is selected for **📷 BUTTON/DIAL SETTING > SHUTTER AE**, exposure for the entire panorama is determined by the first frame.

Viewing Panoramas

With the panorama displayed full frame, press the focus stick (focus lever) down to start panorama playback. Vertical panoramas will scroll vertically, horizontal panoramas horizontally.

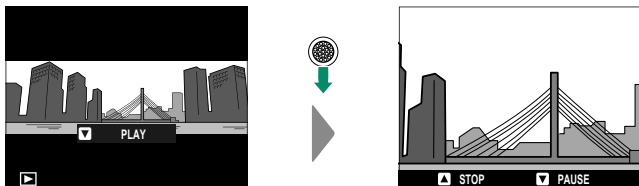

- In full-frame playback, you can use the rear command dial to zoom panoramas in or out.
- Panorama playback is controlled using the focus stick.

Focus stick (focus lever)	Full-frame playback	Panorama playback	Panorama playback paused
Up	—	End playback	
Down	Start playback	Pause playback	Resume playback
Left/right	View other pictures	Choose pan direction	Scroll panorama manually

Multiple Exposures

Create a photograph that combines multiple exposures.

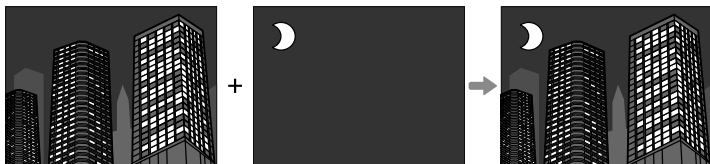

- 1 Press the **DRIVE** button to display the drive mode options and select **MULTIPLE EXPOSURE**.

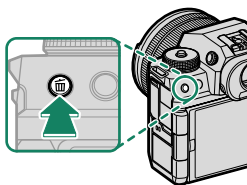

- 2 Choose a blend mode.

Option	Description
ADDITIVE	The camera adds the exposures together. You may need to lower exposure compensation depending on the number of shots.
AVERAGE	The camera automatically optimizes exposure for the final picture. The background in series shot without changing the composition will be optimally exposed.
BRIGHT	The camera compares the exposures and chooses only the brightest pixel at each location. Colors may be mixed depending on their brightness and hue.
DARK	The camera compares the exposures and chooses only the darkest pixel at each location. Colors may be mixed depending on their brightness and hue.

- 3 Take the first shot.

- 4 Press **MENU/OK**. The first shot will be shown superimposed on the view through the lens and you will be prompted to take the second shot.



- To return to the previous step and retake the first shot, press the focus stick (focus lever) left.
- To save the first shot and exit without creating a multiple exposure, press **DISP/BACK**.

- 5 Take the second shot, using the first frame as a guide.

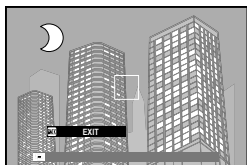

- 6 Press **MENU/OK**. The combined exposures will be displayed as a guide to composing the next shot.



- To return to the previous step and retake the second shot, press the focus stick left.
- To end shooting and create a multiple exposure from the shots taken to this point, press **DISP/BACK**.

- 7 Make additional exposures.
Each photograph can contain up to nine exposures.

- 8 Press **DISP/BACK** to end shooting.
The camera will create the combined image and multiple exposure shooting will end.

Pixel-Shift Multi-Shot

The camera takes a series of 20 shots, using in-body image stabilization to move the image sensor by half a pixel with each shot and recording each frame in RAW format. Using specialized computer software, the frames can then be combined to create a high-resolution RAW picture.

- 1 Press the **DRIVE** button to display the drive mode options and select **PIXEL SHIFT MULTI SHOT**.

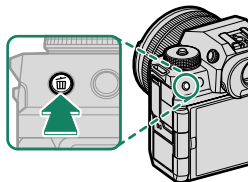

- 2 Choose a value for **INTERVAL**.
 - We recommend setting **INTERVAL** to **SHORTEST**.
 - If you intend to use the flash with every shot, choose a value for **INTERVAL** long enough to allow the flash to charge between shots.
- 3 Press the shutter button to start shooting.
 - The shots are recorded to the memory card in RAW format.
 - To minimize vibration, use the self-timer or a remote release.
- 4 Combine the shots on a computer.
 - The shots can be combined using FUJIFILM Pixel Shift Combiner.
 - To save high-resolution RAW pictures in other formats, use Capture One Express for Fujifilm, Capture One for Fujifilm, or Capture One Pro, available from Capture One A/S. FUJIFILM X RAW STUDIO and RAW FILE CONVERTER EX powered by SILKYPIX cannot be used for this purpose.



• Visit the websites below to learn more about or download the following computer software:

– **FUJIFILM Pixel Shift Combiner:**

<https://fujifilm-x.com/products/software/pixel-shift-combiner/>

– **Capture One Express for Fujifilm:**

<https://www.captureone.com/products-plans/capture-one-express/fujifilm>

– **Capture One for Fujifilm:**

<https://www.captureone.com/explore-features/fujifilm>

– **Capture One Pro:**

<https://www.captureone.com/explore-features>

• Pixel-shift multi-shot photography can be performed via tethered shooting. For this purpose, use FUJIFILM Pixel Shift Combiner.

• The flash will synchronize with the shutter at shutter speeds of $\frac{1}{25}$ s or slower.

• The following limitations apply to the use of the pixel-shift multi-shot option:

- Pixel-shift multi-shot photography can only be performed using the electronic shutter.
- Sensitivity is restricted to a maximum of ISO 1600. Choosing higher values or a setting of **AUTO** results in a sensitivity of ISO 1600, while lower values remain unchanged.
- The only option available for **RAW RECORDING** is **LOSSLESS COMPRESSED**.
- Pictures taken with **CONTINUOUS AF** selected for focus mode will be shot using **SINGLE AF**. Pictures taken with **SINGLE AF** or **MANUAL FOCUS** selected are shot in the chosen focus mode.
- If the subject or camera moves during shooting, the desired results may not be achieved when the shots are combined.
-  **SHOOTING SETTING > FLICKER REDUCTION** is automatically set to **OFF**.
- The value selected for exposure compensation applies to all 20 shots.

Playback

Pictures taken using the pixel-shift multi-shot option are indicated by a pixel-shift multi-shot icon in full-frame playback (📖 216).

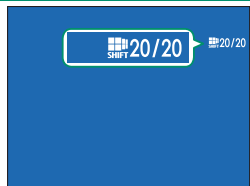

The Shooting Menu

6

IMAGE QUALITY SETTING (Still Photography)

Adjust image quality settings for still photography.

To display image quality settings, press **MENU/OK** in the photo shooting display and select the **IQ** (IMAGE QUALITY SETTING) tab.

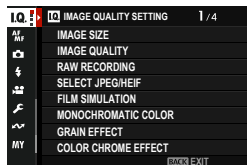

 The options available vary with the shooting mode selected.

IMAGE SIZE

Choose the size and aspect ratio at which still pictures are recorded.

Option	Image size
L 3:2	7728 × 5152
L 16:9	7728 × 4344
L 1:1	5152 × 5152

Option	Image size
L 4:3	6864 × 5152
L 5:4	6432 × 5152

Option	Image size
M 3:2	5472 × 3648
M 16:9	5472 × 3080
M 1:1	3648 × 3648

Option	Image size
M 4:3	4864 × 3648
M 5:4	4560 × 3648

Option	Image size
S 3:2	3888 × 2592
S 16:9	3888 × 2184
S 1:1	2592 × 2592

Option	Image size
S 4:3	3456 × 2592
S 5:4	3264 × 2592

The following options are available in **SPORTS FINDER MODE** and when **1.29X CROP** is selected in burst mode:

Option	Image size
M 3:2	6000 × 4000
M 16:9	6000 × 3376
M 1:1	4000 × 4000

Option	Image size
M 4:3	5328 × 4000
M 5:4	4992 × 4000

 **IMAGE SIZE** is not reset when the camera is turned off or another shooting mode is selected.

IMAGE QUALITY

Choose a file format and compression ratio.

Option	Description
FINE	Low compression ratios are used for higher-quality images.
NORMAL	Higher compression ratios are used to increase the number of images that can be stored.
FINE + RAW	Record both RAW and fine-quality JPEG or HEIF images.
NORMAL + RAW	Record both RAW and normal-quality JPEG or HEIF images.
RAW	Record RAW images only.

The Function Buttons

To toggle RAW image quality on or off for a single shot, assign **RAW** to a function button (☰ 297). Press the button once to select the option in the right column, again to return to the original setting (left column).

Option currently selected for IMAGE QUALITY	Option selected by pressing function button to which RAW is assigned
FINE	FINE + RAW
NORMAL	NORMAL + RAW
FINE + RAW	FINE
NORMAL + RAW	NORMAL
RAW	FINE

RAW RECORDING

Choose whether to compress RAW images.

Option	Description
UNCOMPRESSED	RAW images are not compressed.
LOSSLESS COMPRESSED	RAW images are compressed using a reversible algorithm that reduces file size with no loss of image data. The images can be viewed in Capture One Express for Fujifilm ¹ , Capture One for Fujifilm ¹ , Capture One ¹ , RAW FILE CONVERTER EX powered by SILKYPPIX ² , FUJIFILM X RAW STUDIO, or other software that supports “lossless” RAW compression. Quality is the same as UNCOMPRESSED , but the resulting files are anywhere from about 30 to 90 percent of their uncompressed size.
COMPRESSED	RAW images are compressed using a “lossy”, non-reversible algorithm. Quality is about the same as UNCOMPRESSED , but the resulting files are anywhere from about 25 to 35 percent of their uncompressed size.

1 For information on when support will be available, visit:

<https://www.captureone.com/>

2 For information on when support will be available, visit:

<https://fujifilm-x.com/support/compatibility/software/raw-file-converter-ex-powered-by-silkypix/>

SELECT JPEG/HEIF















Choose whether pictures are recorded in JPEG or HEIF.





Option	Description
JPEG	Pictures are recorded in the widely-supported JPEG format.
HEIF	Pictures are recorded in HEIF, a format with excellent compression but limited options for viewing and sharing.

- 
 • **JPEG** is automatically selected in place of **HEIF** during filter-effect, panorama, multiple-exposure, and HDR photography.
- Selecting **HEIF** disables **CLARITY** and sets **COLOR SPACE** to **sRGB**.
- HEIF pictures are stored on the memory card as files with the extension ".HIF". Before the pictures can be viewed on a computer, the extension must be changed to ".HEIC". This occurs automatically when HEIF pictures are uploaded from the camera to a computer via USB.

FILM SIMULATION

Simulate the effects of different kinds of film, including black-and-white (with or without color filters). Choose a palette according to your subject and creative intent.

Option	Description
 PROVIA/STANDARD	Ideal for a wide range of subjects.
 Velvia/VIVID	Vibrant reproduction, ideal for landscape and nature.
 ASTIA/SOFT	Softer color and contrast for a more subdued look.
 CLASSIC CHROME	Soft color and enhanced shadow contrast for a calm look.
 PRO Neg. Hi	Ideal for portrait with slightly enhanced contrast.
 PRO Neg. Std	Ideal for portrait with soft gradations and skin tones.
 CLASSIC Neg.	Enhanced color with hard tonality to increase image depth.
 NOSTALGIC Neg.	Amber tinted highlights and rich shadow tone for printed photo look.
 ETERNA/CINEMA	Soft color and rich shadow tone suitable for film look movie.
 ETERNA BLEACH BYPASS	Unique color with low saturation and high contrast. Suitable for still and movie.
 ACROS	<p>Shoot in Black and White In rich details with sharpness. Available with yellow (Ye), red (R), and green (G) filters, which deepen shades of gray corresponding to hues complementary to the selected color.</p> <ul style="list-style-type: none"> •  ACROS+Ye FILTER: Slightly enhances contrast and darkens skies. •  ACROS+R FILTER: Enhances contrast and darkens skies considerably. •  ACROS+G FILTER: Produces pleasing skin tones in portrait.

Option	Description
 MONOCHROME	Shoots in black and white. Available with yellow (Ye), red (R), and green (G) filters, which deepen shades of gray corresponding to hues complementary to the selected color. <ul style="list-style-type: none"> •  MONOCHROME+Ye FILTER: Slightly enhances contrast and darkens skies. •  MONOCHROME+R FILTER: Enhances contrast and darkens skies considerably. •  MONOCHROME+G FILTER: Produces pleasing skin tones in portrait.
 SEPIA	Shoots in sepia tone.

-  Film simulation options can be combined with tone and sharpness settings.
- Film simulation settings can also be accessed via shortcuts (🗨️ 288).
- For more information, visit:
https://fujifilm-x.com/global/tag/the-world-of-film-simulation/?post_type=xstories

MONOCHROMATIC COLOR

Add a reddish or bluish tinge (warm or cool color cast) to the **A** ACROS and **B** MONOCHROME monochrome film simulations. Color can be adjusted on the **WARM-COOL** and **G (Green)-M (Magenta)** axes.

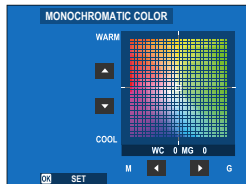

GRAIN EFFECT

Add a film grain effect.

ROUGHNESS

Option	Description
STRONG	Choose for rougher grains.
WEAK	Choose for smoother grains.
OFF	Turn the effect off.

SIZE

Option	Description
LARGE	Choose for coarser grains.
SMALL	Choose for finer grains.

COLOR CHROME EFFECT

Increase the range of tones available for rendering colors that tend to be highly saturated, such as reds, yellows, and greens.

Option	Description
STRONG	Choose for a strong effect.
WEAK	Choose for a weak effect.
OFF	Turn the effect off.

COLOR CHROME FX BLUE

Increase the range of tones available for rendering blues.

Option	Description
STRONG	Choose for a strong effect.
WEAK	Choose for a weak effect.
OFF	Turn the effect off.













SMOOTH SKIN EFFECT





Smooth complexions.

Option	Description
STRONG	Choose for a strong effect.
WEAK	Choose for a weak effect.
OFF	Turn the effect off.

WHITE BALANCE

For natural colors, choose a white balance option that matches the light source.

Option	Description
 AUTO WHITE PRIORITY	White balance is adjusted automatically. Choose for whiter whites in scenes lit by incandescent bulbs.
AUTO	White balance is adjusted automatically.
 AUTO AMBIENCE PRIORITY	White balance is adjusted automatically. Choose for warmer whites in scenes lit by incandescent bulbs.
 CUSTOM 1	Measure a value for white balance.
 CUSTOM 2	
 CUSTOM 3	
 COLOR TEMPERATURE	Choose a color temperature.
 DAYLIGHT	For subjects in direct sunlight.
 SHADE	For subjects in the shade.
 FLUORESCENT LIGHT-1	Use under “daylight” fluorescent lights.
 FLUORESCENT LIGHT-2	Use under “warm white” fluorescent lights.
 FLUORESCENT LIGHT-3	Use under “cool white” fluorescent lights.
 INCANDESCENT	Use under incandescent lighting.
 UNDERWATER	Reduces the blue cast typically associated with underwater lighting.

-  In conditions in which **AUTO** fails to produce the desired results—for example, under certain types of lighting or in close-ups of portrait subjects—use custom white balance or choose a white balance option suited to the light source.
- White balance is adjusted for flash lighting only in **AUTO**,  **AUTO WHITE PRIORITY**,  **AUTO AMBIENCE PRIORITY**, and  modes. Turn the flash off using other white balance options.
- White balance options can also be accessed via shortcuts ( 288).

Fine-Tuning White Balance

Pressing **MENU/OK** after selecting a white balance option displays a fine-tuning dialog; use the focus stick (focus lever) to fine-tune white balance.

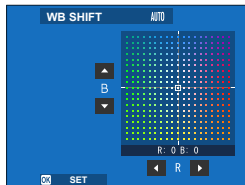

- To exit without fine-tuning white balance, press **DISP/BACK** after selecting a white balance option.
- You cannot tilt the focus stick diagonally when fine-tuning white balance.

Custom White Balance

Choose \square_1 , \square_2 , or \square_3 to adjust white balance for unusual lighting conditions using a white object as a reference (colored objects can also be used to lend photos a color cast). A white balance target will be displayed; position and size the target so that it is filled by the reference object and press the shutter button all the way down to measure white balance (to select the most recent custom value and exit without measuring white balance, press **DISP/BACK**, or press **MENU/OK** to select the most recent value and display the fine-tuning dialog).

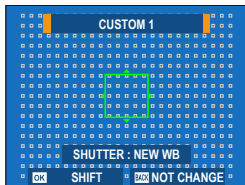

- If **"COMPLETED!"** is displayed, press **MENU/OK** to set white balance to the measured value.
- If **"UNDER"** is displayed, raise exposure compensation and try again.
- If **"OVER"** is displayed, lower exposure compensation and try again.

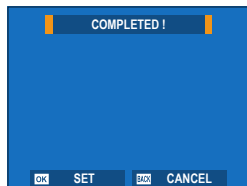

K: Color Temperature

Adjust white balance to match the color temperature of the light source.

 Color temperature can be adjusted to make pictures "warmer" or "colder" or deliberately produce colors that differ radically from those in real life.

- 1 Select **K** in the white balance menu. The option currently selected for color temperature will be displayed.

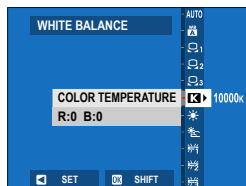

- 2 Edit the color temperature using the focus stick (focus lever) and press **MENU/OK**. A fine-tuning dialog will be displayed.

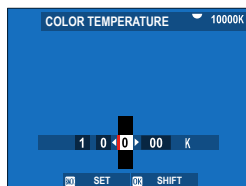

- You can also adjust color temperature in increments of 10 K by rotating the rear command dial.
- Choose from values of from 2500 to 10000 K.
- To exit without fine-tuning white balance, press **DISP/BACK** after choosing a color temperature.

- 3 Highlight a fine-tuning amount using the focus stick.
- 4 Press **MENU/OK**. The changes will be applied. The selected color temperature will appear in the display.

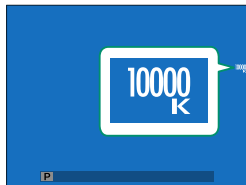

Color Temperature

Color temperature is an objective measure of the color of a light source, expressed in Kelvin (K). Light sources with a color temperature close to that of direct sunlight appear white; light sources with a lower color temperature have a yellow or red cast, while those with a higher color temperature are tinged with blue.

DYNAMIC RANGE

Adjust dynamic range. Wide dynamic ranges reduce loss of detail in highlights for more natural results with high-contrast or backlit scenes.

Option	Description
AUTO	100% Choose for increased contrast.
	200%
	400% Reduce loss of detail in highlights.

Mottling may appear in pictures taken at higher values. Choose a value according to the scene.

- If **AUTO** is selected, the camera will automatically choose either 100% or 200% according to the subject and shooting conditions. Shutter speed and aperture will be displayed when the shutter button is pressed halfway.
- 200% is available at sensitivities of from ISO 250 to ISO 12800, 400% at sensitivities of from ISO 500 to 12800.

D RANGE PRIORITY

Reduce loss of detail in highlights and shadows for natural-looking results when photographing high-contrast scenes.

Option	Description
AUTO	Contrast is adjusted automatically in response to lighting conditions.
STRONG	Adjust dynamic range by a large amount for very high-contrast scenes.
WEAK	Adjust dynamic range by a smaller amount for moderately high-contrast scenes.
OFF	Contrast reduction off.

- WEAK** is available at sensitivities of from ISO 250 to ISO 12800, **STRONG** at sensitivities of from ISO 500 to 12800.
- When an option other than **OFF** is selected, **TONE CURVE**, and **DYNAMIC RANGE** will be adjusted automatically; if you wish to adjust these settings manually, choose **OFF**.

TONE CURVE

With reference to a tone curve, adjust the appearance of highlights or shadows, making them harsher or softer. Choose higher values to make shadows and highlights harsher, lower values to make them softer.

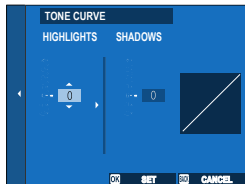

Option	Description
HIGHLIGHTS	-2 to +4
SHADOWS	-2 to +4

COLOR

Adjust color density.

Options								
-4	-3	-2	-1	0	+1	+2	+3	+4

SHARPNESS

Sharpen or soften outlines.

Options								
-4	-3	-2	-1	0	+1	+2	+3	+4

HIGH ISO NR

Reduce noise in pictures taken at high sensitivities. Choose higher values to reduce noise and smooth outlines, lower values to leave outlines visible.

Options								
-4	-3	-2	-1	0	+1	+2	+3	+4

CLARITY

Increase definition while altering tones in highlights and shadows as little as possible. Choose higher values for increased definition, lower values for a softer effect.

Options										
-5	-4	-3	-2	-1	0	+1	+2	+3	+4	+5

 The additional processing required at settings other than 0 increases the time need to save each shot.

LONG EXPOSURE NR

Select **ON** to reduce mottling in long time-exposures.

Options	
ON	OFF

 The additional processing required when **ON** is selected increases save times.

LENS MODULATION OPTIMIZER

Select **ON** to improve definition by adjusting for diffraction and the slight loss of focus at the periphery of the lens.

Options	
ON	OFF

COLOR SPACE

Choose the gamut of colors available for color reproduction.

Option	Description
sRGB	Recommended in most situations.
Adobe RGB	For commercial printing.

PIXEL MAPPING

Use this option if you notice bright spots in your pictures.

- 1 Press **MENU/OK** in the shooting display and select the  **IMAGE QUALITY SETTING** tab.
- 2 Highlight **PIXEL MAPPING** and press **MENU/OK** to perform pixel mapping.

-  • Results are not guaranteed.
- Be sure the battery is fully charged before beginning pixel mapping.
 - Pixel mapping is not available when the camera temperature is elevated.
 - Processing may take a few seconds.

EDIT/SAVE CUSTOM SETTING

Save custom camera settings for commonly-encountered situations. Saved settings can be recalled by rotating the mode dial to positions **C1 (CUSTOM 1)** through **C7 (CUSTOM 7)** ( 83).

AUTO UPDATE CUSTOM SETTING

Choose whether changes to saved custom settings apply automatically.

Option	Description
ENABLE	Changes to custom settings banks CUSTOM 1 through CUSTOM 7 apply automatically.
DISABLE	Changes do not apply automatically. Any changes to custom settings must be applied manually ( 85).

CUSTOM MODE SETTING

Choose whether the current custom settings bank is to be used for still photography or movie recording ( 83).

MOUNT ADAPTOR SETTING

Adjust settings for lenses attached via a mount adaptor. The camera can store settings for multiple lenses (**LENS 1** through **LENS 6**).

-  **DISTORTION CORRECTION**, **COLOR SHADING CORRECTION**, and **PERIPHERAL ILLUMINATION CORRECTION** are available with lenses connected via an M mount adaptor.
 - Any changes made using this item also apply in movie mode (📖 202).

FOCAL LENGTH SETTING

Enter the lens's true focal length.

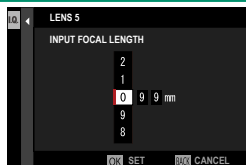

DISTORTION CORRECTION

Choose from **STRONG**, **MEDIUM**, or **WEAK** options to correct **BARREL** or **PINCUSHION** distortion.



COLOR SHADING CORRECTION

Color (shading) variations between the center and edges of the frame can be adjusted separately for each corner.

To use color shading correction, follow the steps below.

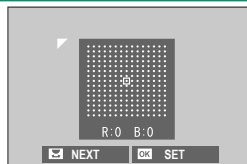



- 1 Rotate the rear command dial to choose a corner. The selected corner is indicated by a triangle.
- 2 Use the focus stick (focus lever) to adjust shading until there is no visible difference in color between the selected corner and the center of the image.
 - Press the focus stick left or right to adjust colors on the cyan–red axis.
 - Press the focus stick up or down to adjust colors on the blue–yellow axis.

 To determine the amount required, adjust color shading correction while taking photos of blue sky or a sheet of gray paper.

PERIPHERAL ILLUMINATION CORRECTION

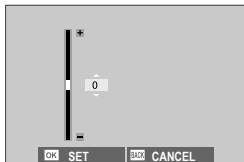
Choose from values between -5 and $+5$. Choosing positive values increases peripheral illumination, while choosing negative values reduces peripheral illumination. Positive values are recommended for vintage lenses, negative values to create the effect of images taken with an antique lens or a pinhole camera.



 To determine the amount required, adjust peripheral illumination correction while taking photos of blue sky or a sheet of gray paper.

EDIT LENS NAME

Change the lens name.

AF/MF SETTING (Still Photography)

Adjust focus settings for still photography.

To display AF/MF settings, press **MENU/OK** in the photo shooting display and select the **AF/MF** (AF/MF SETTING) tab.

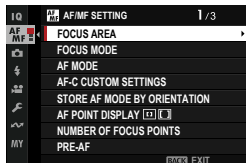

 The options available vary with the shooting mode selected.

FOCUS AREA

Choose the focus area for autofocus, manual focus, and focus zoom ( 96).

FOCUS MODE

Choose how the camera focuses ( 92).

AF MODE

Choose how the camera focuses in modes **AF-S** and **AF-C** ( 94).

AF-C CUSTOM SETTINGS

Select focus-tracking options for **CONTINUOUS AF** focus mode. Choose from Sets 1 (**SET 1**) through 5 (**SET 5**) according to your subject or select **SET 6 CUSTOM** for custom focus-tracking options.

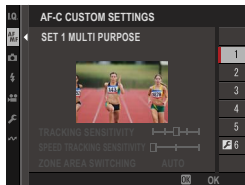

Option	Description
SET 1 MULTI PURPOSE	A standard tracking option that works well with the typical range of moving subjects.
SET 2 IGNORE OBSTACLES & CONTINUE TO TRACK SUBJECT	The focus system attempts to track the chosen subject. Choose with subjects that are hard to keep in the focus area or if other objects are likely to enter the focus area with the subject.
SET 3 FOR ACCELERATING/ DECELERATING SUBJECT	The focus system attempts to compensate for subject acceleration or deceleration. Choose for subjects prone to rapid changes in velocity.
SET 4 FOR SUDDENLY APPEARING SUBJECT	The focus system attempts to focus quickly on subjects entering the focus area. Choose for subjects that appear abruptly or when rapidly switching subjects.
SET 5 FOR ERRATICALLY MOVING & ACCEL./DECEL. SUBJECT	Choose for hard-to-track subjects prone not only to sudden changes in velocity but also to large movements front to back and left to right.
SET 6 CUSTOM	Adjust TRACKING SENSITIVITY , SPEED TRACKING SENSITIVITY , and ZONE AREA SWITCHING to suit your preferences based on the values for Sets 1–5 (📖 150, 152).

Focus Tracking Options

The individual parameters that are part of a focus tracking set are described below.

TRACKING SENSITIVITY

This parameter determines how long the camera waits to switch focus when an object enters the focus area behind or in front of the current subject. The higher the value, the longer the camera will wait.

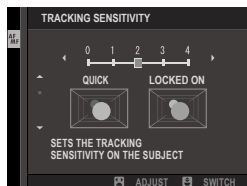

Options

0

1

2

3

4

- ! The higher the value, the longer it takes the camera to refocus when you attempt to switch subjects.
- The lower the value, the more likely the camera is to switch focus from your subject to other objects in the focus area.

SPEED TRACKING SENSITIVITY

This parameter determines how sensitive the tracking system is to changes in subject velocity. The higher the value, the greater the precision with which the system attempts to respond to sudden movement.

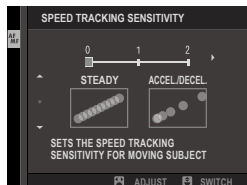

Options

0

1

2

- ! The higher the value, the more difficulty the camera will have focusing in situations in which autofocus does not perform well, such as when the subject is highly reflective or low in contrast.

ZONE AREA SWITCHING

This parameter determines the focus area given priority in zone AF.

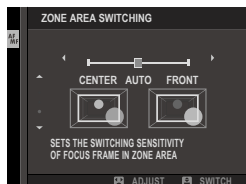

Option	Description
FRONT	Zone AF assigns priority to the subjects closest to the camera.
AUTO	The camera locks focus on the subject at the center of the zone and then switches focus areas as necessary to track it.
CENTER	Zone AF assigns priority to subjects in the center of the zone.

 This option takes effect only when  **ZONE** is selected for AF mode.

Set Values

Parameter values for the different sets are listed below.

	TRACKING SENSITIVITY	SPEED TRACKING SENSITIVITY	ZONE AREA SWITCHING
SET 1	2	0	AUTO
SET 2	3	0	CENTER
SET 3	2	2	AUTO
SET 4	0	1	FRONT
SET 5	3	2	AUTO

Custom Focus Tracking Options

Follow the steps below to adjust settings for Set 6.

- 1 Select **AF-C CUSTOM SETTINGS > SET 6 CUSTOM**.

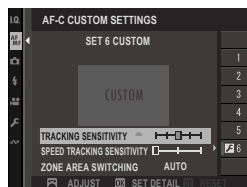

- 2 Highlight items using the focus stick (focus lever) and rotate the front command dial to change. To reset settings to their original values, press .
- 3 Press **DISP/BACK** when settings are complete.

STORE AF MODE BY ORIENTATION

Choose whether the AF mode used when the camera is in portrait orientation is stored separately from that used when the camera is in landscape orientation.

Option	Description
OFF	The same settings are used in both orientations.
FOCUS AREA ONLY	The focus area for each orientation can be selected separately.
ON	The focus mode and focus area can be selected separately.

AF POINT DISPLAY

Choose whether individual focus frames are displayed when **ZONE** or **WIDE/TRACKING** is selected for **AF/MF SETTING > AF MODE**.

Options	
ON	OFF

NUMBER OF FOCUS POINTS

Choose the number of focus points available for focus-point selection in manual focus mode or when **SINGLE POINT** is selected for **AF MODE**.

Option	Description
117 POINTS (9 × 13)	Choose from 117 focus points arranged in a 9- by 13-point grid.
425 POINTS (17 × 25)	Choose from 425 focus points arranged in a 17- by 25-point grid.

PRE-AF

If **ON** is selected, the camera will continue to adjust focus even when the shutter button is not pressed halfway. The camera adjusts focus continuously, allowing it to focus faster when the shutter button is pressed halfway. Choosing this option helps prevent missed shots.

Options	
ON	OFF



 Choosing **ON** increases the drain on the battery.

AF ILLUMINATOR

If **ON** is selected, the AF-assist illuminator will light to assist autofocus.

Options	
ON	OFF





-  • The camera may be unable to focus using the AF-assist illuminator in some cases.
- If the camera is unable to focus, try increasing the distance to the subject.
 - Avoid shining the AF-assist illuminator directly into your subject's eyes.

 Any changes made using this item also apply in movie mode ( 205).

FACE/EYE DETECTION SETTING



If the camera detects human faces, it will assign them priority over the background and adjust settings appropriately for portraits when setting focus and exposure. You can also choose whether the camera focuses on the left or right eye when face detection is on.



Option	Description
FACE DETECTION ON	Adjust settings for Intelligent Face Detection. You can also adjust eye detection settings. <ul style="list-style-type: none"> •  EYE OFF: Intelligent Face Detection only. •  EYE AUTO: The camera automatically chooses which eye to focus on when a face is detected. •  RIGHT EYE PRIORITY: The camera focuses preferentially on the right eye of subjects detected using Intelligent Face Detection. •  LEFT EYE PRIORITY: The camera focuses preferentially on the left eye of subjects detected using Intelligent Face Detection.
OFF	Intelligent Face Detection and eye priority off.







- 
 • If the subject moves as the shutter button is pressed, the face may not be in the area indicated by the green border when the picture is taken.
- In some modes, the camera may set exposure for the frame as a whole rather than the portrait subject.
- Enabling Intelligent Face Detection via **FACE DETECTION ON** automatically selects **OFF** for **SUBJECT DETECTION SETTING**.





- A single face detected in or near the focus area will be marked with a white frame.
- If multiple faces are detected in the focus area, the camera will select one automatically.
- You can choose a different subject by tapping the display to reposition the focus area. The focus stick (focus lever) can also be used if **[] WIDE** is selected for **AF MODE**.
- When **DIRECT AF POINT SELECTION** or **EDIT FOCUS AREA** is chosen for **[] BUTTON/DIAL SETTING > FOCUS LEVER SETTING > TILT** , you can also switch subjects using the focus stick (focus lever) or (during viewfinder photography) touch controls ( 31).
- When the camera is focused on an eye, you can switch from one eye to the other using a function button to which **RIGHT/LEFT EYE SWITCH** has been assigned.
- If the selected subject leaves the frame, the camera will wait a set time for its return and consequently the white frame may sometimes appear in locations where no face is seen.
- Depending on shooting conditions, face selection may be suspended at the close of burst shooting.
- Faces can be detected with the camera in vertical or horizontal orientation.
- If the camera is unable to detect the subject's eyes because they are hidden by hair, glasses, or other objects, the camera will instead focus on faces.
- Face/eye detection options can also be accessed via shortcuts ( 288).



SUBJECT DETECTION SETTING

Choose whether the camera prioritizes subjects of a selected type, such as animals or vehicles, when setting focus.

Option	Description
SUBJECT DETECTION ON	Select one of the subject types listed below to enable subject detection. <ul style="list-style-type: none"> •  ANIMAL: The camera detects and tracks focus on dogs and cats. •  BIRD: The camera detects and tracks focus on birds. •  AUTOMOBILE: The camera detects and tracks focus on the body or front ends of cars, primarily those of types used for motor sports. •  MOTORCYCLE&BIKE: The camera detects and tracks focus on the riders of motorcycles and bicycles. •  AIRPLANE: The camera detects and tracks focus on the cockpits, noses, or bodies of airplanes. •  TRAIN: The camera detects and tracks focus on the driver compartments or front ends of trains.
OFF	Subject detection off.



 Enabling subject detection via **SUBJECT DETECTION ON** automatically selects **OFF** for  **FACE/EYE DETECTION SETTING**.



- A single subject of the chosen type detected in or near the focus area will be marked with a white frame.
- If multiple subjects are detected in the focus area, the camera will select one automatically.
- You can choose a different subject by tapping the display to reposition the focus area. The focus stick (focus lever) can also be used if **[] WIDE** is selected for **AF MODE**.
- When **DIRECT AF POINT SELECTION** or **EDIT FOCUS AREA** is chosen for **[] BUTTON/DIAL SETTING > FOCUS LEVER SETTING > TILT** , you can also switch subjects using the focus stick (focus lever) or (during viewfinder photography) touch controls ( 31).
- If the selected subject leaves the frame, the camera will wait a set time for its return and consequently the white frame may sometimes appear in locations where no subject of the chosen type is seen.
- Depending on shooting conditions, subject detection may be suspended at the close of burst shooting.
- Subjects can be detected with the camera in vertical or horizontal orientation.
- Subject detection options can also be accessed via shortcuts ( 288).

AF+MF

If **ON** is selected and focus has been locked (whether by pressing the shutter button halfway or by other means), focus lock can be ended and focus adjusted manually by rotating the focus ring.

Options	
ON	OFF
 <ul style="list-style-type: none"> Lenses with a focus distance indicator must be set to manual focus mode (MF) before this option can be used. Selecting MF disables the focus distance indicator. If the lens is equipped with a focus distance indicator, set the focus ring to the center, as the camera may fail to focus if the ring is set to infinity or the minimum focus distance. 	
 <ul style="list-style-type: none"> The previously-selected focus mode will be restored if no operations are performed for a set period after the focus ring is rotated. DIGITAL SPLIT IMAGE and DIGITAL MICROPISM focus assist options selected via MF ASSIST cannot be used. 	

AF + MF Focus Zoom

Selecting **ON** for  **AF/MF SETTING** > **FOCUS CHECK** when **SINGLE POINT** is chosen for **AF MODE** lets you zoom in on the current focus area by rotating the focus ring. The zoom ratio can be selected using the rear command dial.

MF ASSIST

Choose how focus is displayed in manual focus mode (📖 103).

Option	Description
DIGITAL SPLIT IMAGE	Displays a black-and-white (MONOCHROME) or color (COLOR) split image in the center of the frame. Frame the subject in the split-image area and rotate the focus ring until the four parts of the split image are correctly aligned.
DIGITAL MICROPRISM	A grid pattern that emphasizes blur is displayed when the subject is out of focus, disappearing to be replaced by a sharp image when the subject is in focus.
FOCUS PEAK HIGHLIGHT	The camera heightens high-contrast outlines. Choose a color and peaking level.
OFF	Focus is displayed normally (focus peaking, digital split image, and digital microprism are not available).

FOCUS CHECK

If **ON** is selected, the display will automatically zoom in on the selected focus area when the focus ring is rotated in manual focus mode.

Options	
ON	OFF
	<ul style="list-style-type: none">• Press the focus stick (focus lever) to cancel focus zoom.• The zoom position is centered on the current focus area and changes when the focus area is changed.

INTERLOCK SPOT AE & FOCUS AREA



Select **ON** to meter the current focus frame when **SINGLE AF** or **CONTINUOUS AF** is selected for **FOCUS MODE**.

Options	
ON	OFF

INSTANT AF SETTING

Chooses how the camera focuses when a button to which focus lock or **AF-ON** is assigned is pressed with **MANUAL FOCUS** selected for **FOCUS MODE**.



Option	Description
AF-S	The camera focuses when the button is pressed.
AF-C	The camera focuses while the button is pressed.

 Any changes made using this item also apply in movie mode ( 206).

DEPTH-OF-FIELD SCALE

Choose the basis for the depth-of-field scale.

Option	Description
PIXEL BASIS	Provides a precision reference for use when assessing depth of field for pictures that will be viewed at high resolutions on computers or other electronic displays.
FILM FORMAT BASIS	Provides a practical reference for use when assessing depth of field for pictures that will be viewed at lower resolutions, for example as prints.

 Any changes made using this item also apply in movie mode ( 206).

RELEASE/FOCUS PRIORITY

Choose how the camera focuses when the shutter button is pressed all the way down with **SINGLE AF** or **CONTINUOUS AF** selected for **FOCUS MODE**.

Option	Description
RELEASE	Shutter response is prioritized over focus. Pictures can be taken when the camera is not in focus.
FOCUS	Focus is prioritized over shutter response. Pictures can be only taken when the camera is in focus.



 Regardless of the option selected, pictures can still be taken when the camera is not in focus if **ON** is selected for **AF+MF**.

AF RANGE LIMITER

Limit the range of available focus distances for increased focus speed.









Option	Description
OFF	Focus limiter disabled.
CUSTOM	Limit focus to a range of distances defined by a minimum and maximum. <ul style="list-style-type: none"> • OK: Limit focus to the selected range. • SET: Choose two objects and limit focus to the distance between them.
PRESET1	Limit focus to a preset range.
PRESET2	



-  Choosing a focus range that includes distances shorter than the minimum focus distance of the lens disables the focus limiter.
- The values listed and displayed for the focus limiter may differ from the actual focus distance.
- Focus range can be set independently on lenses equipped with focus range selectors. Be sure that the option selected in the camera menu overlaps with that chosen with the lens.

-  The following additional operations can be performed when **CUSTOM** is selected:
 - You can tap objects in the touch screen display to choose the focus range.
 - Instead of tapping an object in the display, you set the maximum focus distance to infinity by rotating the focus ring.
- Any changes made using this item also apply in movie mode ( 206).

TOUCH SCREEN MODE

Choose the shooting operations performed using touch controls.

Mode	Description
 TOUCH SHOOTING	Tap your subject in the display to focus and release the shutter. In burst mode, pictures will be taken while you keep your finger on the display.
 AF   AF OFF	<ul style="list-style-type: none">• In focus mode  (SINGLE AF), the camera focuses when you tap your subject in the display. Focus locks at the current distance until you tap the AF OFF icon.• In focus mode  (CONTINUOUS AF), the camera initiates focus when you tap your subject display. The camera will continue to adjust focus for changes in the distance to the subject until you tap the AF OFF icon.• In manual focus mode  (MANUAL FOCUS), you can tap the display to focus on the selected subject using autofocus.
 AREA	Tap to select a point for focus or zoom. The focus frame will move to the selected point.
 OFF	Touch controls disabled.

 To disable touch controls and hide the touch screen mode indicator, select **OFF** for  **BUTTON/DIAL SETTING** > **TOUCH SCREEN SETTING** >  **TOUCH SCREEN SETTING**.

Touch Controls for Focus Zoom

Different touch controls are used during focus zoom (focus check enabled).

Central Area

Tapping the center of the display performs the operations below.

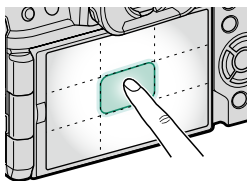

Mode	Operation performed
TOUCH SHOOTING	SINGLE AF/MANUAL FOCUS: Take a picture
AF	SINGLE AF: AF
	MANUAL FOCUS: Instant AF
AREA	SINGLE AF: AF
	MANUAL FOCUS: Instant AF
OFF	SINGLE AF/MANUAL FOCUS: OFF

Other Areas

Tapping other areas simply scrolls the display, whether during still photography or movie recording and regardless of the option selected for touch screen mode.

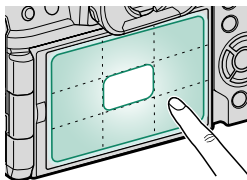

SHOOTING SETTING (Still Photography)

Adjust shooting options for still photography.

To display shooting settings, press **MENU/OK** in the photo shooting display and select the **SHOOTING SETTING** tab.

The options available vary with the shooting mode selected.



FILTER SETTING

Choose the filter used when the mode dial is rotated to **FILTER** (82).

SPORTS FINDER MODE

Take pictures using the crop in the center of the display. Choose this option for pictures of athletes, birds, and other moving subjects.

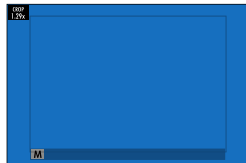

Option	Description
ON	Pictures are taken using a 1.29× crop, reducing the picture angle by an amount equivalent to increasing lens focal length by 1.29×; the crop is shown by a frame in the display.
OFF	The 1.29× crop is disabled.

- The **IMAGE QUALITY SETTING** > **IMAGE SIZE** item in the shooting menu is fixed at **M**.
- The sports finder is not available in modes that offer an electronic shutter.



PRE-SHOT ES 

To reduce the lag between your pressing the shutter button all the way down and the resulting picture being recorded to the memory card, the camera starts shooting with the electronic shutter when the shutter button is pressed halfway and saves a series of shots starting just before the shutter button is pressed the rest of the way down.

Options	
ON	OFF
 <ul style="list-style-type: none"> • Pre-shot photography is available only when ES ELECTRONIC SHUTTER is selected in CH (high speed burst) drive mode (📖 173). • Flash photography is disabled. 	

SELF-TIMER

Choose a shutter release delay.

Option	Description
 2 SEC	The shutter is released two seconds after the shutter button is pressed. Use to reduce blur caused by the camera moving when the shutter button is pressed. The self-timer lamp blinks as the timer counts down.
 10 SEC	The shutter is released ten seconds after the shutter button is pressed. Use for photographs in which you wish to appear yourself. The self-timer lamp blinks immediately before the picture is taken.
OFF	Self-timer off.

If an option other than **OFF** is selected, the timer will start when the shutter button is pressed all the way down. The display shows the number of seconds remaining until the shutter is released. To stop the timer before the picture is taken, press **DISP/BACK**.



-  • Stand behind the camera when using the shutter button. Standing in front of the lens can interfere with focus and exposure.
- The self-timer turns off automatically when the camera is turned off.

SAVE SELF-TIMER SETTING

If **ON** is selected, the chosen self-timer setting will remain in effect after a picture is taken or the camera is turned off.

Options	
ON	OFF

SELF-TIMER LAMP

If **ON** is selected, the self-timer lamp will light during self-timer photography. Select **OFF** when shooting night scenes or in other situations in which you would prefer that the lamp remain unlit.

Options	
ON	OFF

INTERVAL TIMER SHOOTING

Configure the camera to take photos automatically at a preset interval.

- 1 Highlight **INTERVAL TIMER SHOOTING** in the  (**SHOOTING SETTING**) tab and press **MENU/OK**.

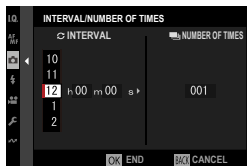

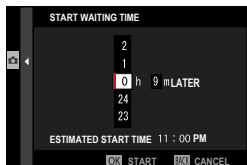

- 2 Use the focus stick (focus lever) to choose the interval and number of shots. Press **MENU/OK** to proceed.

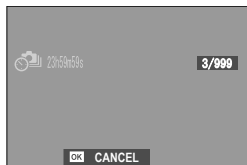

- 3 Use the focus stick to choose the starting time and then press **MENU/OK**. Shooting will start automatically.



 Interval timer photography cannot be used at a shutter speed of “bulb” or with multiple exposure photography. In burst mode, only one picture will be taken each time the shutter is released.

-  • Use of a tripod is recommended.
- We recommend using an AC-5VJ AC power adapter.
- The display turns off between shots and lights a few seconds before the next shot is taken.
- The display can be activated at any time by pressing the shutter button.
- To continue shooting until the number of shots taken equals the number of exposures remaining at the time interval-timer photography started, set the number of shots to ∞ .

INTERVAL TIMER SHOOTING EXPOSURE SMOOTHING

Select **ON** to automatically adjust exposure during interval-timer photography to prevent it changing dramatically between shots.

Options	
ON	OFF

-  Large changes in subject brightness may make exposure appear erratic. We recommend that you choose shorter values for **INTERVAL TIMER SHOOTING > INTERVAL** with subjects that brighten or dim dramatically during shooting.
- In manual mode (mode **M**), exposure smoothing is only available if an AUTO option is selected for **ISO**.

AE BKT SETTING

Adjust exposure bracketing settings.

Option	Description
FRAMES/STEP SETTING	Choose the number of shots in the bracketing sequence and the amount exposure is varied with each shot. <ul style="list-style-type: none">• FRAMES: Choose the number of shots in the bracketing sequence.• STEP: Choose the amount exposure is varied with each shot.
1 FRAME/CONTINUOUS	<ul style="list-style-type: none">• 1 FRAME: The shots in the bracketing sequence are taken one at a time.• CONTINUOUS: The shots in the bracketing sequence are taken in a single burst.
SEQUENCE SETTING	Choose the order in which the shots are taken.

FILM SIMULATION BKT

Choose the three film simulation types used for film simulation bracketing (📖 132).

FOCUS BKT SETTING

Choose from **AUTO** and **MANUAL** focus bracketing modes (📖 116).

PHOTOMETRY

Choose how the camera meters exposure (📖 107).

SHUTTER TYPE

Choose the shutter type. Choose the electronic shutter to mute the shutter sound.

Option	Description
MS MECHANICAL SHUTTER	Take pictures with the mechanical shutter.
ES ELECTRONIC SHUTTER	Take pictures with the electronic shutter.
EF E-FRONT CURTAIN SHUTTER	Take pictures with the electronic front curtain shutter.
M/E MECHANICAL + ELECTRONIC	The camera chooses the mechanical or electronic shutter according to shooting conditions.
E_M E-FRONT + MECHANICAL	The camera chooses the mechanical or electronic front curtain shutter according to shooting conditions.
E_{M/E} E-FRONT + MECHANICAL + ELECTRONIC	The camera chooses the mechanical, electronic, or electronic front curtain shutter according to shooting conditions.

-  • When using the electronic shutter, note the following:
 - Distortion may be visible in shots of moving subjects.
 - Distortion may also be visible in hand-held shots taken at high shutter speeds; use of a tripod is recommended.
 - Banding and fog may occur in shots taken under fluorescent lights or other flickering or erratic illumination.
 - When taking pictures with the shutter muted (🔇 254), respect your subjects' image rights and right to privacy.
- When using the electronic front-curtain shutter, note the following:
 - Faster shutter speeds are more likely to result in uneven exposure and loss of resolution in out-of-focus areas of the frame.

-  The following restrictions apply when the electronic shutter is used:
 - Sensitivity is restricted to values of ISO 12800–125
 - Long exposure noise reduction has no effect
 - The flash will not fire unless pixel-shift multi-shot is enabled.

FLICKER REDUCTION

Reduce flicker in pictures and the display when shooting under fluorescent lighting and other similar light sources.

Option	Description
ALL FRAMES	Flicker reduction is applied to all frames continuous shooting frame rate reduces.
FIRST FRAME	Flicker measurement is taken prior to the first frame only and the same reduction amount is applied to all subsequent frames that flicker may occur.
OFF	Flicker reduction disabled.

-  Flicker reduction increases the time needed to record pictures.
- **OFF** is selected for **FLICKER REDUCTION** when the electronic shutter is used.
- Flicker reduction is not available during movie recording.

FLICKERLESS S.S. SETTING

Select **ON** to allow shutter speed to be fine-tuned to reduce flicker caused by LED lighting and the like.

Options	
ON	OFF

-  This option takes effect only in modes **S** and **M**.

IS MODE

Turn image stabilization on or off.

Option	Description
CONTINUOUS	Image stabilization on.
SHOOTING ONLY	Image stabilization enabled only when the shutter button is released (or, if CONTINUOUS AF is selected for AF/ MF SETTING > FOCUS MODE , while the shutter button is pressed halfway).
OFF	Image stabilization off;  appears in the display.

-  The setting selected with the lens image stabilization switch, if any, takes priority over the setting chosen with **IS MODE**.
- Note that vibration or camera sounds may be noticeable as image stabilization takes effect.

ISO

Adjust the camera's sensitivity to light ( 105).

DIGITAL TELE-CONV.

Zoom in on your subject during shooting using ultra-high-resolution digital zoom.

Option	Description
2.0x	Take pictures using 2× zoom. L - and M -size pictures are automatically cropped to size S .
1.4x	Take pictures using 1.4× zoom. L -size pictures are automatically cropped to size M .
OFF	Digital teleconverter off.

 Image quality may drop when the digital teleconverter is used.

-  The digital teleconverter cannot be used when a 1.29× crop is selected during burst photography or when **ON** is selected for **SPORTS FINDER MODE**.

COOLING FAN SETTING

Adjust settings for optional cooling fans ( 336).

Option	Description
AUTO1	The fan turns on automatically as required when camera temperature rises and runs at slow speed.
AUTO2	The fan turns on automatically as required when camera temperature rises and runs at high speed. The increased fan noise may be audible in movies.
LOW	Run the fan continuously at low speed.
HIGH	Run the fan continuously at high speed. The increased fan noise may be audible in movies.
OFF	Turn the fan off.

WIRELESS COMMUNICATION

Connect to smartphones running the latest version of apps. The smartphone can then be used to:

- Control the camera and take pictures remotely
- Receive pictures uploaded from the camera
- Browse the pictures on the camera and download selected pictures
- Upload location data to the camera

 For more information, visit:
<https://app.fujifilm-dsc.com/>

FLASH SETTING (Still Photography)

Adjust flash-related settings for still photography.

To display flash settings, press **MENU/OK** in the photo shooting display and select the **⚡ (FLASH SETTING)** tab.

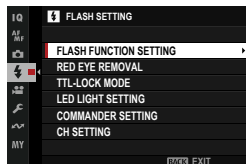

FLASH FUNCTION SETTING

Choose a flash control mode, flash mode, or sync mode or adjust the flash level. The options available vary with the flash.

 For more information on flash settings, see “External Flash Units” (📖 317) in “Peripherals and Optional Accessories”.

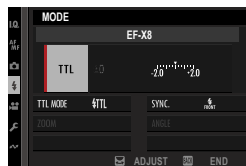

RED EYE REMOVAL

Remove red-eye effects caused by the flash.

Option	Description
FLASH	Flash red-eye reduction only.
OFF	Flash red-eye reduction and digital red-eye removal off.

 Flash red-eye reduction can be used in TTL flash control mode.

TTL-LOCK MODE

Instead of adjusting flash level with each shot, TTL flash control can be locked for consistent results across a series of photographs.

Option	Description
LOCK WITH LAST FLASH	Flash output is locked at the value metered for the most recent photo.
LOCK WITH METERING FLASH	The camera emits a series of pre-flashes and locks flash output at the metered value.

- To use TTL lock, assign **TTL-LOCK** to a camera control and then use the control to enable or disable TTL lock (📖 297).
- Flash compensation can be adjusted while TTL lock is in effect.
- Selecting **LOCK WITH LAST FLASH** displays an error message if no previously metered value exists.

LED LIGHT SETTING

Choose whether to use the flash unit's LED video light (if available) as a catchlight or AF-assist illuminator when taking photos.

Option	Role of LED video light in still photography
CATCHLIGHT	Catchlight
AF ASSIST	AF-assist illuminator
AF ASSIST+CATCHLIGHT	AF-assist illuminator and catchlight
OFF	None

- In some cases, this option can also be accessed via the **FLASH FUNCTION SETTING** menu.

COMMANDER SETTING

Choose groups when using the camera flash unit as a commander for Fujifilm optical wireless remote flash control. This option is available when the camera is used with clip-on flash units that support Fujifilm optical wireless flash control.

Options			
Gr A	Gr B	Gr C	OFF

 In some cases, this option can also be accessed via the **FLASH FUNCTION SETTING** menu.

CH SETTING

Choose the channel used for communication between the commander and remote flash units. Separate channels can be used for different flash systems or to prevent interference when multiple systems are operating in close proximity.

Options			
CH1	CH2	CH3	CH4

MOVIE SETTING (Still Photography)

Adjust options for movies shot during still photography using the  (movie recording) button.

To display movie settings, press **MENU/OK** in the photo shooting display and select the  (**MOVIE SETTING**) tab.

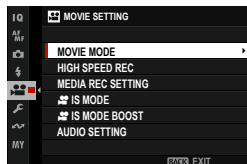

 The options available vary with the shoot-
ing mode selected.

MOVIE MODE

This item is also found in the movie menus ( 185). Changes here also apply to the item in the movie menus.

HIGH SPEED REC

This item is also found in the movie menus ( 186). Changes here also apply to the item in the movie menus.

MEDIA REC SETTING

This item is also found in the movie menus ( 187). Changes here also apply to the item in the movie menus.

IS MODE

This item is also found in the movie menus ( 195). Changes here also apply to the item in the movie menus.

IS MODE BOOST

This item is also found in the movie menus ( 195). Changes here also apply to the item in the movie menus.

AUDIO SETTING

Adjust audio-related settings for movie recording.

INTERNAL MIC LEVEL ADJUSTMENT

Adjust the recording level for the built-in microphone.

Option	Description
AUTO	The camera adjusts the recording level automatically.
MANUAL	Adjust the recording level manually. Choose from 25 recording levels.
OFF	Turn the built-in microphone off.

EXTERNAL MIC LEVEL ADJUSTMENT

Adjust the recording level for external microphones.

Option	Description
AUTO	The camera adjusts the recording level automatically.
MANUAL	Adjust the recording level manually. Choose from 25 recording levels.
OFF	Disable recording using external microphones.

MIC JACK SETTING

Specify the type of hardware connected to the microphone jack.

Option	Description
MIC	Choose this option for direct connection to an external microphone.
LINE	Choose this option for external audio devices connected via line output.

MIC LEVEL LIMITER

Reduces distortion caused by input that exceeds the limits of the microphone's audio circuits.

Options	
ON	OFF

WIND FILTER

Choose whether to enable wind noise reduction during movie recording.

Options	
ON	OFF

LOW CUT FILTER

Choose whether to enable the low-cut filter, reducing low-frequency noise during movie recording.

Options	
ON	OFF

HEADPHONES VOLUME

Adjust the headphone volume.

Option	Description
0	Mute output to the headphones.
1—10	Choose a volume of from 1 to 10.

XLR MIC ADAPTER SETTING

Adjust microphone input channel settings and the like for use with XLR microphone adapters.

Option	Description
MIC INPUT CHANNEL	<p>Record four-channel (quadraphonic) sound with the help of the camera's built-in microphone, or two-channel (stereo) sound using only a microphone connected via the XLR microphone adapter.</p> <ul style="list-style-type: none"> • 4ch XLR+CAMERA: Record four-channel sound with the help of the camera's built-in microphone. • 2ch XLR ONLY: Record two-channel sound using only an external microphone connected via the XLR microphone adapter.
4ch AUDIO MONITORING	<p>Choose the source of sound output to headphones or other audio monitors during movie recording.</p> <ul style="list-style-type: none"> • XLR: Monitor sound from external microphones connected via the XLR microphone adapter. • CAMERA: Monitor sound from camera's built-in microphone.
HDMI 4ch AUDIO OUTPUT	<p>Choose source of audio output to the HDMI connector.</p> <ul style="list-style-type: none"> • XLR: Audio from external microphones connected via the XLR microphone adapter is output to the HDMI connector. • CAMERA: Audio from camera's built-in microphone is output to the HDMI connector.



- If an external microphone is connected to the camera's microphone jack, audio will be recorded not via the camera's built-in microphone but via the external microphone instead.
- Four-channel recording is available only when MOV is selected for movie file format.

MOVIE SETTING (Movie Recording)

Adjust movie-recording options.

To display options for movie recording, press **MENU/OK** in the movie shooting display and select the  (**MOVIE SETTING**) tab.



MOVIE SETTING LIST

View current movie recording settings.

 These options can also be viewed by pressing the **DISP/BACK** button while the movie quick menu is displayed.

SHOOTING MODE

Choose a shooting mode for movies.

Options			
PROGRAM AE	SHUTTER PRIORITY AE	APERTURE PRIORITY AE	MANUAL

MOVIE MODE

Before shooting movies, choose the frame rate and the frame size and aspect ratio.

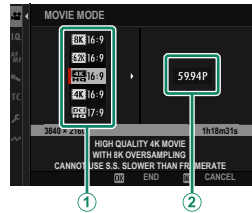

- 1 In the shooting menu, select **MOVIE SETTING**, then highlight **MOVIE MODE** and press **MENU/OK**.
- 2 Press the focus stick (focus lever) up or down to highlight the desired frame size and aspect ratio (①) and press the stick right.
 - Choose **8K 16:9** for 8 K movies with an aspect ratio of 16:9.
 - Choose **6.2K 16:9** for 6.2 K movies with an aspect ratio of 16:9.
 - Choose **4K HQ 16:9** or **4K HQ 17:9** for high-quality 4 K movies with aspect ratios of 16 or 17 to 9.
 - Choose **4K 16:9** or **4K 17:9** for 4K movies with aspect ratios of 16 or 17 to 9.
 - Choose **FHD 16:9** or **FHD 17:9** for Full HD movies with aspect ratios of 16 or 17 to 9.
- 3 Press the focus stick (focus lever) up or down to highlight a frame rate (②) and press **MENU/OK**.

Options					
23.98P	24P	25P	29.97P	50P	59.94P

 The choice of frame rates varies with the movie mode.

HIGH SPEED REC

Record high-frame-rate movies. High-frame-rate movies can be played back in slow motion, giving you time to view fast-moving subjects or details too fleeting for the naked eye. Select **ON** to choose the recording and playback rates separately.

 Choose **ON HDMI ONLY** to record footage only to external recorders connected via HDMI. Note that this option does not support playback frame-rate selection.

Frame Size

Options

FHD 16:9

FHD 17:9

Playback

Options

23.98P

24P

25P

29.97P

50P

59.94P

Recording

Options

100P

120P

200P

240P

-  High-speed movies are recorded with no sound.
- The footage recorded to the memory card is compressed with the goal of maintaining the selected bit rate.
- The options available for playback rate vary with the option selected for rate of recording.

MEDIA REC SETTING

Choose movie file settings, including destination, file type, bit rate, and proxy video.

MEDIA REC SETTING

Choose movie file settings, including destination, file type, and compression.

Destination

Choose save options and save and output destinations for movies.

Option	Description
1	Movies are recorded only to the memory card in Slot 1.
2	Movies are recorded only to the memory card in Slot 2.
1→2	Footage is recorded to the memory card in Slot 1 until the card fills. Any additional footage will then automatically be recorded to the card in Slot 2.
1+2	Each movie is recorded twice, once to each card.
HDMI	Movies are recorded only to devices connected via HDMI.

 The current movie mode applies to both copies; settings for backup copies cannot be adjusted separately.

File Type and Compression

Choose the movie file type and compression.

Option	Description
H.264 ALL-I 420 MOV	A highly-portable compressed format. Footage is recorded at a depth of 8 bits using All-I interframe compression and 4:2:0 chroma sub-sampling.
H.264 LongGOP 420 MOV	A highly-portable compressed format. Footage is recorded at a depth of 8 bits using Long GOP interframe compression and 4:2:0 chroma sub-sampling.
H.264 LongGOP 420 MP4	A format suitable for movies that will be uploaded to the web.
H.265 ALL-I 420 MOV	A format with a higher compression ratio than H.264. Footage is recorded at a depth of 10 bits using All-I interframe compression and 4:2:0 chroma sub-sampling.
H.265 LongGOP 420 MOV	A format with a higher compression ratio than H.264. Footage is recorded at a depth of 10 bits using Long GOP interframe compression and 4:2:0 chroma sub-sampling.
H.265 ALL-I 422 MOV	A format with a higher compression ratio than H.264. Footage is recorded at a depth of 10 bits using All-I interframe compression and 4:2:2 chroma sub-sampling.
H.265 LongGOP 422 MOV	A format with a higher compression ratio than H.264. Footage is recorded at a depth of 10 bits using Long GOP interframe compression and 4:2:2 chroma sub-sampling.
ProRes HQ MOV*	Record movies in ProRes 422 HQ format.
ProRes 422 MOV*	Record movies in ProRes 422 format.
ProRes LT MOV*	Record movies in ProRes 422 LT format.

* Available only when **1** is selected as the destination.

- The ProRes format is intended for the footage will be edited on a computer or the like.
- 4:2:2 chroma sub-sampling is used for footage output to external devices connected via HDMI; H.264 footage is output at a bit depth of 8 bits and footage in other formats at a depth of 10 bits.
- **All-I** compresses each frame separately. Files are larger, but the fact that the data for each frame are saved separately makes this a good choice for footage that will be further processed.
- **Long GOP** balances good image quality with high compression. Files are smaller, making it a good choice for longer movies.
- The options available for file type and compression vary with the options selected for **MOVIE MODE**, **HIGH SPEED REC**, and **F-Log/HLG RECORDING**.

Bit Rate

Choose the movie bit rate.

Options				
50Mbps	100Mbps	200Mbps	360Mbps	720Mbps

- The options available for bit rate vary with the settings chosen for high-speed movie recording and compression. The bit rate is variable and may not always match the selected setting.
- The bit rate for ProRes movies is set automatically according to the format chosen and the frame size and rate. For more information, visit the Apple website.

PROXY SETTING (ONLY WHEN REC ProRes)

Choose whether the camera simultaneously records a duplicate “proxy” video with movies shot in ProRes format.

Option	Description
ON (H.264)	Record proxy videos in H.264 format.
ON (ProRes Proxy)	Record proxy videos in ProRes Proxy format.
OFF	Proxy recording disabled.

- ❗ Proxy recording is not available at a frame size of 8K if the frame rate is either 29.97P or 25P.
- Deleting the original footage from the camera also deletes the proxy video. The original and proxy videos cannot be deleted separately.
- When deleting movies from camera memory cards using a computer, be sure to delete both the originals and the proxies.

HDMI OUTPUT SETTING

Adjust settings for use when the shooting display is output to an HDMI device.

HDMI OUTPUT INFO DISPLAY

If **ON** is selected, HDMI devices to which the camera is connected will mirror the information in the camera display.

Options	
ON	OFF

HDMI REC CONTROL

Choose whether the camera sends movie start and stop signals to the HDMI device when the shutter button is pressed to start and stop movie recording.

Options	
ON	OFF

RAW OUTPUT SETTING

Choose whether to output RAW footage to external recorders connected via HDMI.

Option	Description
RAW OUTPUT SETTING ATOMOS	Output RAW footage to ATOMOS video recorders.
RAW OUTPUT SETTING Blackmagic	Output RAW footage to Blackmagic Design video recorders.
OFF	Do not output RAW footage to external recorders.



- Movie frame size automatically changes to 8K.
- RAW footage output to external devices is not saved to the memory cards inserted in the camera.
- In-camera image enhancements are not applied to the **RAW** output.
- ISO sensitivity is restricted to values between ISO 800 and ISO 12800.
- Footage output to external devices is generated from the original RAW data and its quality, which varies with device specifications, may not be equal to that achieved as the end result of post-production or the like.
- Focus zoom is not available when **RAW** is selected for HDMI output.
- **RAW** footage output via HDMI to incompatible devices will not display correctly but will instead will display as a mosaic.
- RAW output is disabled in some movie and high-speed recording modes.

FIX MOVIE CROP MAGNIFICATION

Fix the movie crop ratio at 1.25:1. This makes it easier to match crops after changing movie settings.

Options	
ON	OFF









DIGITAL ZOOM



Zoom in on your subject during shooting (compatible lenses only).

Option	Description
ON	Digital zoom enabled. The zoom ratio can be adjusted. Pressing the DRIVE button cancels digital zoom.
OFF	Digital zoom disabled.

F-Log/HLG RECORDING

Choose the destination for F-Log and HLG (Hybrid Log-Gamma) movies shot while the camera is connected to an HDMI device.

Option	Description
 	The footage is processed using film simulation and both saved to the memory card and output to the HDMI device.
 F-Log  F-Log	The footage is recorded to the memory card and output to the HDMI device in F-Log format.
 F-Log2  F-Log2	The footage is recorded to the memory card and output to the HDMI device in F-Log format.
 HLG  HLG	The footage is recorded to the memory card and output to the HDMI device in HLG format.

-  • **F-Log** and **F-Log2** offer gentle gamma curves with wide gamuts suitable for further processing post-production. Sensitivity is restricted to values between ISO 500 and ISO 12800 (**F-Log**) or between ISO 1000 and ISO 12800 (**F-Log2**).
- The **HLG** (Hybrid Log-Gamma) recording format conforms to the international ITU-R BT2100 standard. When viewed on HLG-compatible displays, high-quality HLG footage faithfully captures high-contrast scenes and vivid colors. Sensitivity is restricted to values between ISO 800 and ISO 12800.
- Film simulation () footage is recorded using the option selected for **IMAGE QUALITY SETTING > FILM SIMULATION** in the shooting menu.

DATA LEVEL SETTING

Choose a signal range for movie recording.

Option	Description
VIDEO RANGE	The signal range for 8-bit movies is limited to 16–235 and that for 10-bit movies to 64–940.
FULL RANGE	The signal ranges for 8-bit and 10-bit movies are respectively 0–255 and 0–1023.

PHOTOMETRY

Options are the same as those for still photography, but settings must be adjusted separately ( 107).

FLICKERLESS S.S. SETTING

Options are the same as those for still photography, but settings must be adjusted separately ( 174).

Options	
ON	OFF

IS MODE

Turn image stabilization on or off.

Option	Description
IBIS/OIS	Enable in-body (IBIS) and optical (OIS) image stabilization. IBIS is used with lenses that do not support OIS.
IBIS/OIS + DIS	Enable in-body (IBIS), optical (OIS), and digital (DIS) image stabilization. The crop is adjusted according to the option selected for MOVIE MODE .
OFF	Image stabilization off;  appears in the display.



- The setting selected with the lens image stabilization switch, if any, takes priority over the setting chosen with the IS mode.
- Note that vibration or camera sounds may be noticeable as image stabilization takes effect.

IS MODE BOOST

Choose the image stabilization level.

Option	Description
ON	Suitable for hand-held shooting with no panning.
OFF	Suitable for hand-held shooting with panning.



- Assigning **IS MODE BOOST** to a function button allows the image stabilization level to be changed while recording is in progress ( 297).



ISO

Adjust the camera's sensitivity to light.

Option	Description
H (25600)	Choose for special situations. Note that dynamic range may be reduced and that pictures may be mottled.
125–12800	Adjust sensitivity manually. Selected value is shown in display.
AUTO	Sensitivity is automatically adjusted in response to shooting conditions.

ZEBRA SETTING

Highlights that may be overexposed are shown by zebra stripes in the movie mode display.

Option	Description
ZEBRA RIGHT	 Right-slanting stripes.
ZEBRA LEFT	 Left-slanting stripes.
OFF	Stripes off.

ZEBRA LEVEL

Choose the brightness threshold for the zebra stripe display.

Options										
50	55	60	65	70	75	80	85	90	95	100

MOVIE OPTIMIZED CONTROL

Select **ON** to allow movie settings to be adjusted using only the command dials and touch-screen controls. You may find this helpful in preventing the sounds of camera controls being recorded with movies ( 33).

Options	
ON	OFF

TALLY LIGHT



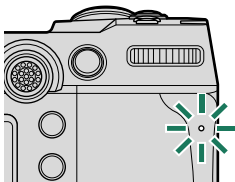



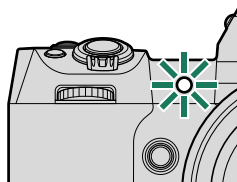

Choose the lamp (indicator or AF-assist) that lights during movie recording and whether the lamp blinks or remains steady.



Indicator lamp



AF-assist illuminator

Option	Description
FRONT OFF REAR 	The indicator lamp lights during movie recording.
FRONT OFF REAR 	The indicator lamp blinks during movie recording.
FRONT  REAR 	The indicator and AF-assist lamps light during movie recording.
FRONT  REAR OFF	The AF-assist lamp lights during movie recording.
FRONT  REAR 	The indicator and AF-assist lamps blink during movie recording.
FRONT  REAR OFF	The AF-assist lamp blinks during movie recording.
FRONT OFF REAR OFF	The indicator and AF-assist lamps remain off during movie recording.

COOLING FAN SETTING

This item is also found in the photo menus ( 176).

EDIT/SAVE CUSTOM SETTING

Options are the same as those for still photography, but settings must be adjusted separately ( 83).

AUTO UPDATE CUSTOM SETTING

This item is also found in the photo menus ( 144).

CUSTOM MODE SETTING

Choose whether the current custom settings bank is to be used for still photography or movie recording ( 83).

WIRELESS COMMUNICATION



This item is also found in the photo menus ( 176).

IMAGE QUALITY SETTING (Movie Recording)

Adjust image quality settings for movies.

To display image quality settings, press **MENU/OK** in the movie shooting display and select the **IQ** (IMAGE QUALITY SETTING) tab.

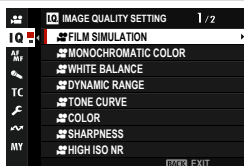

 The options available vary with the shooting mode selected.

FILM SIMULATION

Options are the same as those for still photography, but settings must be adjusted separately ( 132).

MONOCHROMATIC COLOR





Options are the same as those for still photography, but settings must be adjusted separately ( 134).









WHITE BALANCE

Options are the same as those for still photography, but settings must be adjusted separately ( 136).

DYNAMIC RANGE

Choose a dynamic range for movie recording.

Option	Description
 100%	See "DYNAMIC RANGE" ( 140).
 200%	
 400%	

-  • **AUTO** (automatic dynamic range control) is not available during movie recording.
-  200% is available at sensitivities of from ISO 250 to ISO 12800,  400% at sensitivities of from ISO 500 to 12800.
- This item is available when     is selected for  **MOVIE SETTING > F-Log/HLG RECORDING**.

TONE CURVE

Options are the same as those for still photography, but settings must be adjusted separately ( 141).

COLOR

Options are the same as those for still photography, but settings must be adjusted separately ( 141).

SHARPNESS

Options are the same as those for still photography, but settings must be adjusted separately ( 141).

HIGH ISO NR

Options are the same as those for still photography, but settings must be adjusted separately ( 142).

INTERFRAME NR

Select **AUTO** to automatically adjust interframe noise reduction according to shooting conditions.



Options	
AUTO	OFF



"Ghosting" may occur with moving subjects or if the camera is moved during shooting.

PERIPHERAL LIGHT CORRECTION

Select **ON** to enable peripheral illumination correction during movie recording.

Options	
ON	OFF
<ul style="list-style-type: none">  If ON is selected when a lens that does not transmit data to the camera is attached, peripheral illumination will be adjusted according to the option selected for  IMAGE QUALITY SETTING >  MOUNT ADAPTER SETTING > PERIPHERAL ILLUMINATION CORRECTION in the shooting menu (📖 147). Select OFF if you notice banding in movies recorded using this option. 	

MOUNT ADAPTOR SETTING

This item is also found in the photo menus (📖 145). Changes to one apply to the other.

AF/MF SETTING (Movie Recording)

Adjust focus settings for movies.

To display AF/MF settings, press **MENU/OK** in the movie shooting display and select the **AF/MF** (AF/MF SETTING) tab.

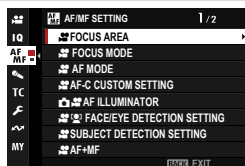

 The options available vary with the shooting mode selected.



FOCUS AREA

Choose the focus area for autofocus, manual focus, and focus zoom ( 96).

 The focus area cannot be resized while recording is in progress.

FOCUS MODE

Choose the focus mode for movie recording.

Option	Description
 MANUAL FOCUS	Focus manually.
 CONTINUOUS AF	The camera focuses using AF-C.
 SINGLE AF	The camera focuses using AF-S.

AF MODE

Choose how the camera selects the focus point for movie recording.

Option	Description
MULTI	The camera selects the focus area automatically.
AREA	The camera focuses on the subject in the selected focus area.

AF-C CUSTOM SETTING

Select focus-tracking options when recording movies with **CONTINUOUS AF** selected for  **FOCUS MODE**.

TRACKING SENSITIVITY

Choose how long the camera waits to switch focus when an object enters the focus area behind or in front of the current subject. See “TRACKING SENSITIVITY” (📖 150).

Options				
0	1	2	3	4

- ⓘ • The higher the value, the longer it takes the camera to refocus when you attempt to switch subjects.
- The lower the value, the more likely the camera is to switch focus from your subject to other objects in the focus area.

AF SPEED

Adjust the autofocus response speed. Choose higher values for faster response times, lower values for slower response times.

Options										
-5	-4	-3	-2	-1	0	+1	+2	+3	+4	+5





AF ILLUMINATOR

This item is also found in the photo menus (📖 154). Changes to one apply to the other.

FACE/EYE DETECTION SETTING

Enable or disable Intelligent Face Detection when recording movies.

Option	Description
FACE DETECTION ON	See "  FACE/EYE DETECTION SETTING" (📖 155).
OFF	Intelligent Face Detection and eye priority off.

 If **SINGLE AF** is chosen for **FOCUS MODE** when **FACE DETECTION ON** is selected for  **AF/MF SETTING** >  **FACE/EYE DETECTION SETTING**, the camera will automatically switch to **CONTINUOUS AF**. Selecting **MANUAL FOCUS** when **FACE DETECTION ON** is selected for  **FACE/EYE DETECTION SETTING** disables Intelligent Face Detection.

SUBJECT DETECTION SETTING

Options are the same as those for still photography, but settings must be adjusted separately (📖 157).

 If **SINGLE AF** is chosen for **FOCUS MODE** when **SUBJECT DETECTION ON** is selected for  **AF/MF SETTING** > **SUBJECT DETECTION SETTING**, the camera will automatically switch to **CONTINUOUS AF**.

AF+MF

Select **ON** to enable manual focus in **SINGLE AF** and **CONTINUOUS AF** modes. Manual focus can be suspended by pressing the **AFON** button.

Options	
ON	OFF

MF ASSIST

Choose how focus is displayed when **MANUAL FOCUS** is selected for **FOCUS MODE** ( 103).

Option	Description
FOCUS PEAK HIGHLIGHT	The camera heightens high-contrast outlines. Choose a color and peaking level.
FOCUS METER	A needle indicates whether focus is in front of or behind the subject.
FOCUS METER + PEAK HIGHLIGHT	Focus is indicated by both a meter and peak highlights.
OFF	Focus is displayed normally (focus peaking and the focus meter are not available).

FOCUS CHECK

Options are the same as those for still photography, but settings must be adjusted separately ( 160).

INSTANT AF SETTING

This item is also found in the photo menus ( 161). Changes to one apply to the other.

 Instant AF is disabled during movie recording. Use instant AF to focus before recording begins.

DEPTH-OF-FIELD SCALE



This item is also found in the photo menus ( 161). Changes to one apply to the other.



AF RANGE LIMITER

This item is also found in the photo menus ( 163). Changes to one apply to the other.

TOUCH SCREEN MODE

Choose the shooting operations performed using touch controls.

Mode	Description
 AF	<p>Tapping the display focuses the camera on the selected point. <i>Use the shutter button to start and stop recording.</i></p> <ul style="list-style-type: none"> • When SINGLE AF is selected for FOCUS MODE, you can refocus at any time by tapping your subject in the display. • When CONTINUOUS AF is chosen for FOCUS MODE, the camera will continuously adjust focus for changes in the distance to the subject at point selected by tapping the display. • When MANUAL FOCUS is selected for FOCUS MODE, the camera will focus using autofocus if you tap the display before recording begins; during recording, you can tap the display again to move the focus area to a new location.
 AREA	<p>Tap to position the focus area. <i>Use the shutter button to start and stop recording.</i></p> <ul style="list-style-type: none"> • When SINGLE AF is selected for FOCUS MODE, you can reposition the focus area at any time by tapping your subject in the display. To focus, use the button to which AF-ON is assigned. • When CONTINUOUS AF is chosen for FOCUS MODE, the camera will continuously adjust focus for changes in the distance to the subject at point selected by tapping the display. • When MANUAL FOCUS is selected for FOCUS MODE, you can tap the display to position the focus area over your subject.
 OFF	<p>Touch controls disabled.</p>

 To disable touch controls and hide the touch screen mode indicator, select **OFF** for  **BUTTON/DIAL SETTING** > **TOUCH SCREEN SETTING** >  **TOUCH SCREEN SETTING**.

Touch Controls for Focus Zoom

Different touch controls are used during focus zoom (focus check enabled).

Central Area

Tapping the center of the display performs the operations below.

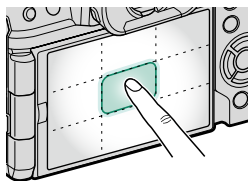

Mode	Operation performed
AF	SINGLE AF: AF
	MANUAL FOCUS: Instant AF
AREA	SINGLE AF: AF
	MANUAL FOCUS: Instant AF
OFF	SINGLE AF/MANUAL FOCUS: OFF

Other Areas

Tapping other areas simply scrolls the display, whether during still photography or movie recording and regardless of the option selected for touch screen mode.

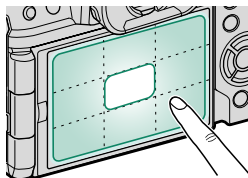
**FOCUS CHECK LOCK**

Choose whether focus zoom remains in effect once movie recording begins.

Options	
ON	OFF

AUDIO SETTING (Movie Recording)

Adjust settings for audio recorded during filming.

To display audio settings, press **MENU/OK** in the movie shooting display and select the  (**AUDIO SETTING**) tab.

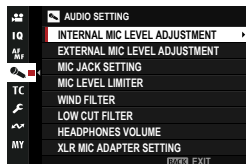

INTERNAL MIC LEVEL ADJUSTMENT

Adjust the recording level for the built-in microphone.

Option	Description
AUTO	The camera adjusts the recording level automatically.
MANUAL	Adjust the recording level manually. Choose from 25 recording levels.
OFF	Turn the built-in microphone off.

EXTERNAL MIC LEVEL ADJUSTMENT

Adjust the recording level for external microphones.

Option	Description
AUTO	The camera adjusts the recording level automatically.
MANUAL	Adjust the recording level manually. Choose from 25 recording levels.
OFF	Disable recording using external microphones.

MIC JACK SETTING

Specify the type of hardware connected to the microphone jack.

Option	Description
MIC	Choose this option for direct connection to an external microphone.
LINE	Choose this option for external audio devices connected via line output.

MIC LEVEL LIMITER

Reduces distortion caused by input that exceeds the limits of the microphone's audio circuits.

Options	
ON	OFF

WIND FILTER

Choose whether to enable wind noise reduction during movie recording.

Options	
ON	OFF

LOW CUT FILTER

Choose whether to enable the low-cut filter, reducing low-frequency noise during movie recording.

Options	
ON	OFF

HEADPHONES VOLUME

Adjust the headphone volume.

Option	Description
0	Mute output to the headphones.
1—10	Choose a volume of from 1 to 10.

XLR MIC ADAPTER SETTING

Adjust microphone input channel settings and the like for use with XLR microphone adapters.

Option	Description
MIC INPUT CHANNEL	<p>Record four-channel (quadraphonic) sound with the help of the camera's built-in microphone, or two-channel (stereo) sound using only a microphone connected via the XLR microphone adapter.</p> <ul style="list-style-type: none"> • 4ch XLR+CAMERA: Record four-channel sound with the help of the camera's built-in microphone. • 2ch XLR ONLY: Record two-channel sound using only an external microphone connected via the XLR microphone adapter.
4ch AUDIO MONITORING	<p>Choose the source of sound output to headphones or other audio monitors during movie recording.</p> <ul style="list-style-type: none"> • XLR: Monitor sound from external microphones connected via the XLR microphone adapter. • CAMERA: Monitor sound from camera's built-in microphone.
HDMI 4ch AUDIO OUTPUT	<p>Choose source of audio output to the HDMI connector.</p> <ul style="list-style-type: none"> • XLR: Audio from external microphones connected via the XLR microphone adapter is output to the HDMI connector. • CAMERA: Audio from camera's built-in microphone is output to the HDMI connector.



- If an external microphone is connected to the camera's microphone jack, audio will be recorded not via the camera's built-in microphone but via the external microphone instead.
- Four-channel recording is available only when MOV is selected for movie file format.

TIME CODE SETTING (Movie Recording)

Adjust time code (hour, minute, second, and frame number) display settings for movie recording.

To display time code settings, press **MENU/OK** in the movie shooting display and select the **TC** (TIME CODE SETTING) tab.

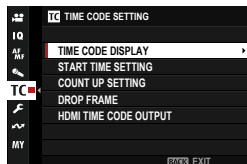

TIME CODE DISPLAY

Select **ON** to display time codes during movie recording and playback.

Options	
ON	OFF

START TIME SETTING

Choose the time code starting time.

Option	Description
MANUAL INPUT	Choose a start time manually.
CURRENT TIME	Set the start time to the current time.
RESET	Set the start time to 00:00:00.

COUNT UP SETTING

Choose whether time is clocked continuously or only during movie recording.

Option	Description
REC RUN	Time is clocked only during movie recording.
FREE RUN	Time is clocked continuously.

DROP FRAME

At frame rates of **59.94P**, and **29.97P**, a discrepancy will gradually develop between the time code (measured in seconds) and the actual recording time (measured in fractions of a second). Choose whether the camera drops frames as necessary to match the recording time to the time code.

Option	Description
ON	The camera drops frames as necessary to maintain a strict match between the time code and the actual recording time.
OFF	Frames are not dropped.

-  The time code display varies with the option selected.



TC:00:00:00:00 

ON

TC:00:00:00:00 

OFF

- Selecting a frame rate of **23.98P** disables frame drop.

HDMI TIME CODE OUTPUT

Choose whether time codes are output to HDMI devices.

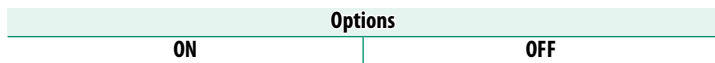

Playback and the Playback Menu

7

The Playback Display

This section lists the indicators that may be displayed during playback.

! For illustrative purposes, displays are shown with all indicators lit.

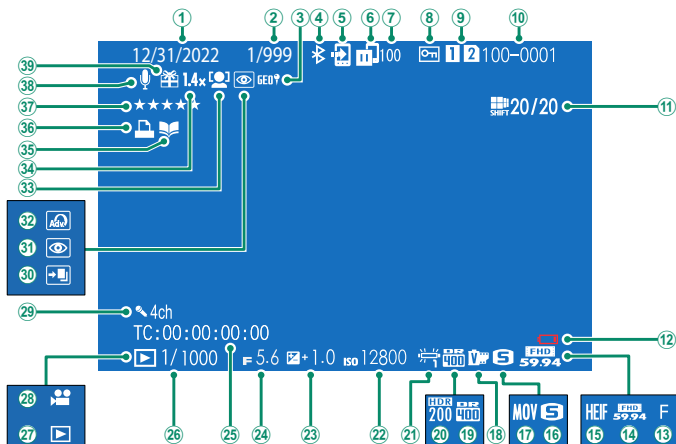

① Date and time.....	52, 54, 247	②① White balance	136
② Frame-number display		②② Sensitivity.....	175
③ Location data.....	286	②③ Exposure compensation.....	108
④ Bluetooth ON/OFF		②④ Aperture.....	73, 76, 78
⑤ Image transfer order		②⑤ Time code.....	212
⑥ Image transfer status		②⑥ Shutter speed.....	73, 74, 78
⑦ Number of frames selected for upload		②⑦ Playback mode indicator.....	59
⑧ Protected image.....	229	②⑧ Movie icon	69
⑨ Card slot.....	221	②⑨ Four-channel (quadrophonic) audio	183, 211
⑩ Frame number.....	283	③① HDR image	118
⑪ Pixel-shift multi-shot	125	③② Red-eye removal indicator.....	177
⑫ Low battery	51	③③ Filter	82
⑬ Image quality.....	129	③④ Face detection indicator	155
⑭ Movie mode	185	③⑤ Digital teleconverter	175
⑮ HEIF.....	131	③⑥ Photobook assist indicator	237
⑯ Image size	128	③⑦ DPOF print indicator.....	239
⑰ Film format.....	188	③⑧ Rating.....	232
⑱ Film simulation	132	③⑨ Voice memo	231
⑲ Dynamic range	140	③⑩ Gift image.....	59
⑳ HDR.....	118		

The DISP/BACK Button

The **DISP/BACK** button controls the display of indicators during playback.

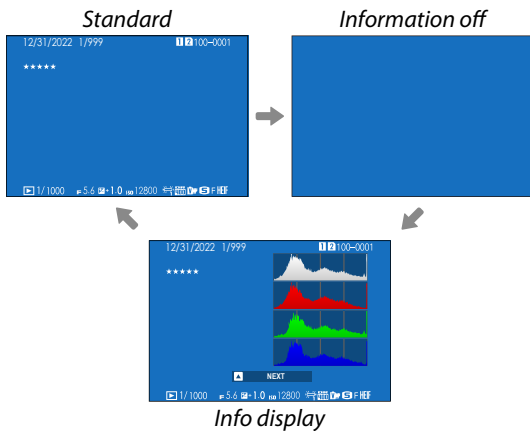
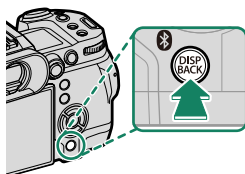

Viewing Photo Information

The photo information display changes each time the focus stick (focus lever) is pressed up.

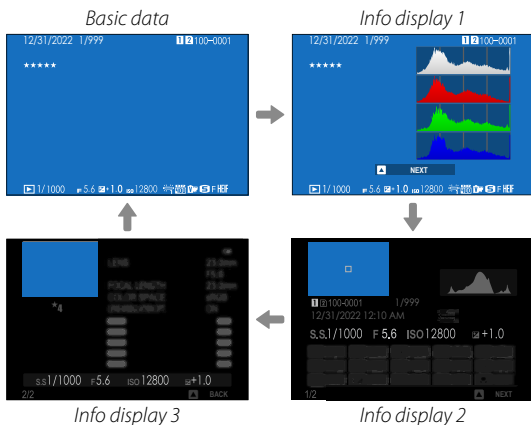
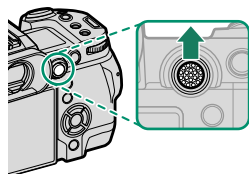

Zooming in on the Focus Point

Press the center of the focus stick (focus lever) to zoom in on the focus point. Press again to return to full-frame playback.

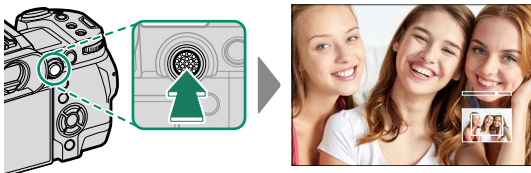

Viewing Pictures

Read this section for information on playback zoom and multi-frame playback.

Use the rear command dial to go from full-frame playback to playback zoom or multi-frame playback.

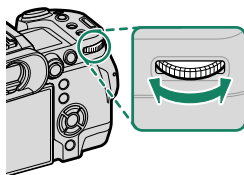

Full-frame playback



Multi-frame playback



Nine-frame view



Hundred-frame view

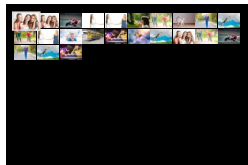

Playback zoom

DISP/BACK
MENU/OK



Medium zoom



Maximum zoom



Playback Zoom

Rotate the rear command dial right to zoom in on the current picture, left to zoom out. To exit zoom, press **DISP/BACK** or **MENU/OK**.

 The maximum zoom ratio varies with the option selected for **IMAGE QUALITY SETTING > IMAGE SIZE**.

Scroll

When the picture is zoomed in, the focus stick (focus lever) can be used to view areas of the image not currently visible in the display.



Navigation window

Multi-Frame Playback

To change the number of images displayed, rotate the rear command dial left when a picture is displayed full frame.

-  • Use the focus stick (focus lever) to highlight images and press **MENU/OK** to view the highlighted image full frame.
- In the nine- and hundred-frame displays, press the focus stick up or down to view more pictures.

The Playback Menu



Adjust playback settings.

The playback menu is displayed when you press **MENU/OK** in playback mode.



SWITCH SLOT

Choose the card from which images will be played back.

 If two memory cards are inserted, you can press and hold the  button to choose a card for playback.

RAW CONVERSION

Even if you don't have a computer, you can use the camera to modify RAW pictures and save them in other formats.

Saving RAW Pictures in Another Format

- 1 Display a RAW picture.
- 2 Highlight **RAW CONVERSION** in the playback menu.
- 3 Press **MENU/OK**.
A list of settings will be displayed.

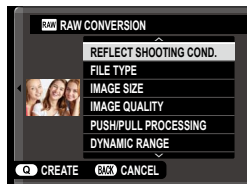

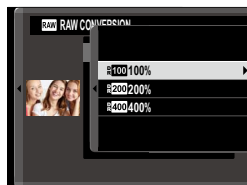

- 4 Press the focus stick (focus lever) up or down to highlight a setting.
- 5 Press the focus stick right to display options.



- 6 Press the focus stick up or down to highlight the desired option.
- 7 Press **MENU/OK** to select the highlighted option. The settings list shown in Step 3 will be displayed. Repeat Steps 4 to 7 to adjust additional settings.
- 8 Press the **Q** button.
A preview of the copy will be displayed.
- 9 Press **MENU/OK**.
The copy will be saved.

 RAW conversion options can also be displayed by pressing the **Q** button when a RAW picture is displayed during playback.

The settings that can be adjusted when converting pictures from RAW to another format are:

Setting	Description
REFLECT SHOOTING COND.	Create a copy using the settings in effect at the time the photo was taken.
FILE TYPE	Choose a file format.
IMAGE SIZE	Choose an image size.
IMAGE QUALITY	Adjust image quality.
PUSH/PULL PROCESSING	Adjust exposure.
DYNAMIC RANGE	Enhance details in highlights for natural contrast.
D RANGE PRIORITY	Reduce loss of detail in highlights and shadows for natural-looking results when photographing high-contrast scenes.
FILM SIMULATION	Simulate the effects of different types of film.
MONOCHROMATIC COLOR	Choose a monochrome tint for photographs taken using FILM SIMULATION >  ACROS and  MONOCHROME .
GRAIN EFFECT	Add a film grain effect.
COLOR CHROME EFFECT	Increase the range of tones available for rendering colors that tend to be highly saturated, such as reds, yellows, and greens.
COLOR CHROME FX BLUE	Increase the range of tones available for rendering blues.
SMOOTH SKIN EFFECT	Smooth complexions.
WHITE BALANCE	Adjust white balance.
WB SHIFT	Fine-tune white balance.
tone CURVE	Adjust highlights and shadows.
COLOR	Adjust color density.
SHARPNESS	Sharpen or soften outlines.
HIGH ISO NR	Process the copy to reduce mottling.
CLARITY	Increase definition.
LENS MODULATION OPTIMIZER	Improve definition by adjusting for diffraction and the slight loss of focus at the periphery of the lens.
COLOR SPACE	Choose the color space used for color reproduction.
HDR MODE	Reduce loss of detail in highlights and shadows.
DIGITAL TELE-CONV.	Switch to the crop in effect when the photo was taken.

 Some settings may be unavailable depending on the options chosen when the picture was taken.

HEIF TO JPEG/TIFF CONVERSION

Convert HEIF pictures to JPEG or TIFF.

SELECT IMAGES

Select HEIF pictures for conversion.

FILE FORMAT

Choose a format for the converted pictures.

Options		
JPEG	TIFF 8bit	TIFF 16bit

SELECT SLOT TO RECORD

Choose the memory card to which the converted pictures will be saved.

Options	
SLOT 1	SLOT 2

ERASE

Delete individual pictures, multiple selected pictures, or all pictures.

 Deleted pictures cannot be recovered. Protect important pictures or copy them to a computer or other storage device before proceeding.

Option	Description
FRAME	Delete pictures one at a time.
SELECTED FRAMES	Delete multiple selected pictures.
ALL FRAMES	Delete all unprotected pictures.

FRAME

- 1 Select **FRAME** for **ERASE** in the playback menu.
- 2 Press the focus stick (focus lever) left or right to scroll through pictures and press **MENU/OK** to delete.

 • A confirmation dialog is not displayed before pictures are deleted; be sure the correct picture is selected before pressing **MENU/OK**.

- Additional pictures can be deleted by pressing **MENU/OK**. Press the focus stick left or right to scroll through pictures and press **MENU/OK** to delete.

SELECTED FRAMES

- 1 Select **SELECTED FRAMES** for **ERASE** in the playback menu.
- 2 Highlight pictures and press **MENU/OK** to select.
 - Selected pictures are indicated by check marks (✓).
 - To deselect a highlighted picture, press **MENU/OK** again.
- 3 When the operation is complete, press **DISP/BACK** to display a confirmation dialog.
- 4 Highlight **OK** and press **MENU/OK** to delete the selected pictures.



Pictures in photobooks or printer orders are shown by **!**.

ALL FRAMES

- 1 Select **ALL FRAMES** for **ERASE** in the playback menu.
- 2 A confirmation dialog will be displayed; highlight **OK** and press **MENU/OK** to delete all unprotected pictures.



- Pressing **DISP/BACK** cancels deletion; note that any pictures deleted before the button was pressed cannot be recovered.
- If a message appears stating that the selected images are part of a DPOF print order, press **MENU/OK** to delete the pictures.

SIMULTANEOUS DELETE

Taking photos with **SEPARATE** selected for **SAVE DATA SET-UP** > **CARD SLOT SETTING** creates two copies. Choose whether deleting the RAW image will also delete the JPEG or HEIF copy.

Option	Description
ON	Deleting the RAW image from the card in Slot 1 also deletes the JPEG or HEIF copy from the card in Slot 2.
OFF	Deleting the RAW image from the card in Slot 1 does not delete the JPEG or HEIF copy from the card in Slot 2.

CROP

Create a cropped copy of the current picture.

- 1 Display the desired picture.
- 2 Select **CROP** in the playback menu.
- 3 Use the rear command dial to zoom in and out and press the focus stick (focus lever) up, down, left, or right to scroll the picture until the desired portion is displayed.
- 4 Press **MENU/OK** to display a confirmation dialog.
- 5 Press **MENU/OK** again to save the cropped copy to a separate file.

-  • The higher the zoom ratio, the smaller the number of pixels in the cropped copy.
- If the size of the final copy will be **640**, **YES** will be displayed in yellow.
- All copies have an aspect ratio of 3:2.

RESIZE

Create a small copy of the current picture.

- 1 Display the desired picture.
- 2 Select **RESIZE** in the playback menu.
- 3 Highlight a size and press **MENU/OK** to display a confirmation dialog.
- 4 Press **MENU/OK** again to save the resized copy to a separate file.



The sizes available vary with the size of the original image.

PROTECT

Protect pictures from accidental deletion. Highlight one of the following options and press **MENU/OK**.

Option	Description
FRAME	Protect selected pictures. Press the focus stick (focus lever) left or right to view pictures and press MENU/OK to select or deselect. Press DISP/BACK when the operation is complete.
SET ALL	Protect all pictures.
RESET ALL	Remove protection from all pictures.

 Protected pictures will be deleted when the memory card is formatted.



-  Protecting images currently selected for upload to paired smartphones or tablets removes upload marking.
- Protection can also be added or removed by pressing the **Fn1** button during playback.

IMAGE ROTATE

Rotate pictures.

- 1 Select **ON** for  **SCREEN SET-UP > AUTOROTATE PB.**
- 2 Display the desired picture.
- 3 Select **IMAGE ROTATE** in the playback menu.
- 4 Press the focus stick (focus lever) down to rotate the picture 90° clockwise, up to rotate it 90° counterclockwise.
- 5 Press **MENU/OK**. The picture will automatically be displayed in the selected orientation whenever it is played back on the camera.



- Protected pictures cannot be rotated. Remove protection before rotating pictures.
- The camera may not be able to rotate pictures created with other devices. Pictures rotated on the camera will not be rotated when viewed on a computer or on other cameras.
- Pictures taken with  **SCREEN SET-UP > AUTOROTATE PB** are automatically displayed in the correct orientation during playback.

VOICE MEMO SETTING

Add a voice memo to the current photograph.

- 1 Select **ON** for **VOICE MEMO SETTING** in the playback menu.
- 2 Display a photo to which you wish to add a voice memo.
- 3 Press and hold the **AFON** button to record a voice memo. Recording ends after 30 s or when you release the button.



- The new memo will be recorded over any existing memos.
- Voice memos cannot be added to protected pictures.
- Deleting the picture also deletes the memo.

Playing Voice Memos

Pictures with voice memos are indicated by  icons during playback.

- To play the memo, press the **AFON** button.
- A progress bar will be displayed while the memo plays back.
- Volume can be adjusted by pressing **MENU/OK** to pause playback and then pressing the focus stick (focus lever) up or down to adjust the volume. Press **MENU/OK** again to resume playback. Volume can also be adjusted using  **SOUND SET-UP > PLAYBACK VOLUME**.

RATING

Rate pictures using stars.

- 1 Select **RATING** in the playback menu.
- 2 Rotate the front command dial to choose a picture and the rear command dial to choose a rating of from 0 to 5 stars ("★").



- The focus stick (focus lever) can be used in place of the front command dial to choose a picture.
- The rating dialog can also be displayed by pressing the **AEL** button in single-frame, nine-frame, or hundred-frame playback.
- Use touch controls to zoom in or out.
- Ratings cannot be applied to:
 - Protected pictures
 - Movies
 - "Gift" pictures (pictures taken with other cameras)

COPY

Copy pictures between the cards in the first and second slots.

- 1 Select **COPY** in the playback menu.
- 2 Highlight one of the following options.

Option	Description
SLOT1 → SLOT2	Copy pictures from the card in the first slot to the card in the second slot.
SLOT2 → SLOT1	Copy pictures from the card in the second slot to the card in the first slot.

- 3 Press the focus stick (focus lever) right.
- 4 Highlight one of the following options and press **MENU/OK**.

Option	Description
FRAME	Copy selected pictures. Press the focus stick left or right to view pictures and press MENU/OK to copy the current picture.
ALL FRAMES	Copy all pictures.

- ⓘ • Copying ends when the destination is full.
- If you attempt to copy a file over 4 GB in size to a memory card with a capacity of 32 GB or less, copying will end and the file will not be copied.

TRANSFER IMAGE TO SMARTPHONE

Select photos for upload to a paired smartphone or tablet via Bluetooth.

 For information on pairing the camera with a smartphone or tablet, visit: https://fujifilm-dsc.com/en/manual/x-h2_connection/

1 Select **TRANSFER IMAGE TO SMARTPHONE** > **SELECT IMAGE & TRANSFER**.

 Select **RESET** to remove “upload to smartphone” marking from all pictures before proceeding.

2 Mark pictures for upload. Highlight pictures and press **MENU/OK** to mark them for upload.

- To switch to the memory card in the other slot or display only pictures that meet selected criteria, press **DISP/BACK** before marking begins.
- To select all pictures, press the **Q** button.
- Selecting any two pictures with the **AEL** button also selects all pictures between them.

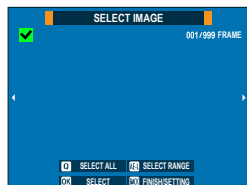

3 Press **DISP/BACK** and select **START TRANSFER**.

The selected pictures will be uploaded.

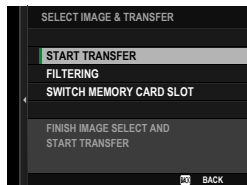

Filtering Pictures/Choosing a Slot

To switch to the memory card in the other slot or display only pictures that meet selected criteria, press **DISP/BACK** in the picture-selection dialog.

- To display only pictures that meet selected criteria, choose **FILTERING**.
- To switch to the memory card in the other slot, choose **SWITCH MEMORY CARD SLOT**.

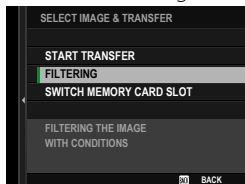

 Switching slots or changing the filter criteria removes any existing upload marking.

-  Image transfer orders can contain a maximum of 999 pictures.
- The following cannot be selected for upload:
 - Protected pictures
 - Movies
 - RAW images
 - “Gift” pictures (pictures taken with other cameras)
- If **ON** is selected for both **IMAGE TRANSFER WHILE POWER OFF** and **Bluetooth/SMARTPHONE SETTING > Bluetooth ON/OFF** in the network/USB settings menu, upload to the paired device will continue even while the camera is off.
- When  **SMARTPHONETRANSFERORDER** is selected for  **BUTTON/DIAL SETTING >  ISO BUTTON SETTING**, the picture-selection dialog can be displayed by pressing the **ISO** button.

WIRELESS COMMUNICATION

Connect to smartphones running the latest apps. The smartphone can then be used to:

- Control the camera and take pictures remotely
- Receive pictures uploaded from the camera
- Browse the pictures on the camera and download selected pictures
- Upload location data to the camera



• For downloads and other information, visit:

<https://app.fujifilm-dsc.com/>

- If  **WIRELESS COMMUNICATION** is selected for  **BUTTON/DIAL SETTING** >  **ISO BUTTON SETTING**, you can connect to the smartphone using the **ISO** button.

SLIDE SHOW

View pictures in an automated slide show. Press **MENU/OK** to start and press the focus stick (focus lever) right or left to skip ahead or back. Press **DISP/BACK** at any time during the show to view on-screen help. The show can be ended at any time by pressing **MENU/OK**.





The camera will not turn off automatically while a slide show is in progress.

PHOTOBOOK ASSIST

Create books from your favorite photos.

Creating a Photobook

- 1 Select **NEW BOOK** for  **PLAY BACK MENU > PHOTOBOOK ASSIST**.
- 2 Scroll through the images and press the focus stick (focus lever) up to select or deselect. Press **MENU/OK** to exit when the book is complete.
- 3 Highlight **COMPLETE PHOTOBOOK** and press **MENU/OK** (to select all photos for the book, choose **SELECT ALL**). The new book will be added to the list in the photobook assist menu.

-  • Neither photographs **640** or smaller nor movies can be selected for photobooks.
- The first picture selected becomes the cover image. Press the focus stick down to select the current image for the cover instead.

-  • Books can contain up to 300 pictures.
- Books that contain no photos are automatically deleted.

Viewing Photobooks

Highlight a book in the photobook assist menu and press **MENU/OK** to display the book, then press the focus stick (focus lever) left or right to scroll through the pictures.

Editing and Deleting Photobooks

Display the photobook and press **MENU/OK**. The following options will be displayed; select the desired option and follow the on-screen instructions.

- **EDIT:** Edit the book as described in “Creating a Photobook”.
- **ERASE:** Delete the book.

PRINT ORDER (DPOF)

Create a digital “print order” for DPOF-compatible printers.

- 1 Select **PLAY BACK MENU > PRINT ORDER (DPOF)**.
- 2 Select **WITH DATE** to print the date of recording on pictures, **WITHOUT DATE** to print pictures without dates, or **RESET ALL** to remove all pictures from the print order before proceeding.
- 3 Display a picture you wish to include in or remove from the print order.
- 4 Press the focus stick (focus lever) up or down to choose the number of copies (up to 99).

To remove a picture from the order, press the focus stick down until the number of copies is 0.

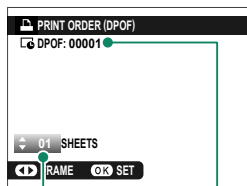

Total number of prints

Number of copies

Repeat steps 3–4 to complete the print order.

- 5 The total number of prints is displayed in the monitor. Press **MENU/OK** to exit.

- The pictures in the current print order are indicated by a  icon during playback.
- Print orders can contain a maximum of 999 pictures from a single memory card.
- If a memory card is inserted containing a print order created by another camera, you will need to delete the order before creating as described above.

instax PRINTER PRINT

To print pictures to optional Fujifilm instax SHARE printers, first select **instax PRINTER CONNECTION SETTING** in the network/USB settings menu and enter the instax SHARE printer name (SSID) and password, then follow the steps below.

- 1 Turn the printer on.
- 2 Select **PLAY BACK MENU > instax PRINTER PRINT**. The camera will connect to the printer.
- 3 Use the focus stick (focus lever) to display the picture you want to print, then press **MENU/OK**. The picture will be sent to the printer and printing will start.



- Pictures taken with other cameras cannot be printed.
- The area printed is smaller than the area visible in the LCD monitor.
- The displays may vary depending on the printer connected.

DISP ASPECT

Choose the aspect ratio used for the display of still pictures on High Definition (HD) devices (this option is available only when an HDMI cable is connected).

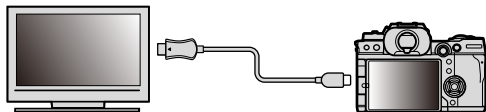

Options

16:9

3:2

-  Choose **16:9** to display photos with an aspect ratio of 3:2 full screen. The pictures will be displayed full screen with tops and bottoms cropped out.

Network/USB Setting Menus



Network/USB Setting Menus

Adjust camera network and USB settings.

For more information on the network/USB settings menu, visit:

https://fujifilm-dsc.com/en/manual/x-h2_connection/

The Setup Menu

9

USER SETTING

Adjust basic camera settings.

To access basic camera settings, press **MENU/OK**, select the **SET UP** tab, and choose **USER SETTING**.

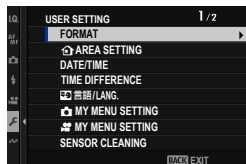



FORMAT

To format a memory card:

- 1 Select **USER SETTING** > **FORMAT** in the **SET UP** tab.
- 2 Highlight the slot containing the card you wish to format and press **MENU/OK**.
- 3 A confirmation dialog will be displayed. To format the memory card, highlight **OK** and press **MENU/OK**.

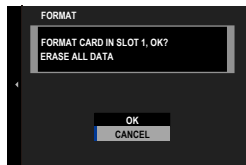
 To exit without formatting the memory card, select **CANCEL** or press **DISP/BACK**.



-  All data—including protected pictures—will be deleted from the memory card. Be sure important files have been copied to a computer or other storage device.
- Do not open the battery-chamber cover during formatting.

 Format options can also be displayed by holding the selector down (▼) while pressing the **DELETE** button.

AREA SETTING

Adjust settings for your current time zone.

AREA SETTING

Choose your time zone from a map.



DAYLIGHT SAVINGS

Turn daylight saving time on or off.

Option	Description
ON	Daylight saving time on.
OFF	Daylight saving time off.

DATE/TIME

To set the camera clock:

- 1 Select  **USER SETTING** > **DATE/TIME** in the  **(SET UP)** tab.
- 2 Press the focus stick (focus lever) left or right to highlight the year, month, day, hour, or minute and press up or down to change. To change the order in which the year, month, and day are displayed, highlight the date format and press the focus stick up or down.
- 3 Press **MENU/OK** to set the clock.



TIME DIFFERENCE



Switch the camera clock instantly from your home time zone to the local time at your destination when traveling. To specify the difference between your local and home time zone:



 Use  **AREA SETTING** to choose your home time zone before selecting a local time zone using  **LOCAL**.

- 1 Highlight  **LOCAL** and press **MENU/OK**.
- 2 Use the focus stick (focus lever) to choose the local time zone. Press **MENU/OK** when settings are complete.

 Select **ON** to enable daylight saving time.

To set the camera clock to local time, highlight  **LOCAL** and press **MENU/OK**. To set the clock to the time in your home time zone, select  **HOME**.



Options	
 LOCAL	 HOME

 If  **LOCAL** is selected,  will be displayed in yellow for about three seconds when the camera is turned on.



 言語/LANG.

Choose a language.

 MY MENU SETTING

Edit the items listed in the  (MY MENU) tab, a personalized custom menu of frequently-used photo menu options ( 289).

 MY MENU SETTING

Edit the items listed in the  (MY MENU) tab, a personalized custom menu of frequently-used movie menu options ( 289).

SENSOR CLEANING

Remove dust from the camera image sensor.

Option	Description
OK	Clean the sensor immediately.
WHEN SWITCHED ON	Sensor cleaning will be performed when the camera is turned on.
WHEN SWITCHED OFF	Sensor cleaning will be performed when the camera turns off (sensor cleaning is not however performed if the camera turns off in playback mode).

 Dust that cannot be removed using sensor cleaning can be removed using a blower (📖 358).

BATTERY AGE

Check battery age. Age is expressed as a number between 0 and 4. The higher the number, the older the battery.

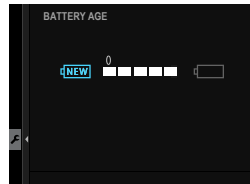



 The older the battery, the faster it loses its charge. We recommend that batteries be replaced as they wear out.

RESET

Reset shooting or setup menu options to default values.

- 1 Highlight the desired option and press **MENU/OK**.

Option	Description
STILL MENU RESET	Reset all photo menu settings other than custom white balance and custom settings banks created using  EDIT/SAVE CUSTOM SETTING to default values.
MOVIE MENU RESET	Reset all movie menu settings other than custom white balance and custom settings banks created using  EDIT/SAVE CUSTOM SETTING to default values.
SET-UP RESET	Reset all setup menu settings other than DATE/TIME ,  AREA SETTING , TIME DIFFERENCE , and COPYRIGHT INFO to default values.
INITIALIZE	Reset all settings other than custom white balance to default values.

- 2 A confirmation dialog will be displayed; highlight **OK** and press **MENU/OK**.

REGULATORY

To view electronic copies of the product model number, and other certificates, select  **USER SETTING > REGULATORY** in the setup menu.

SOUND SETTING

Make changes to camera sounds.

To access sound settings, press **MENU/OK**, select the **SET UP** tab, and choose **SOUND SET-UP**.

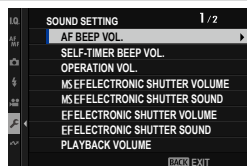

AF BEEP VOL.

Choose the volume of the beep that sounds when the camera focuses. The beep can be muted by selecting **OFF**.

Options

🔊 (high)

🔊 (medium)

🔊 (low)

🔊 OFF (mute)

SELF-TIMER BEEP VOL.

Choose the volume of the beep that sounds while the self-timer is active. The beep can be muted by selecting **OFF**.

Options

🔊 (high)





🔊 (medium)

🔊 (low)

🔊 OFF (mute)





OPERATION VOL.

Adjust the volume of the sounds produced when camera controls are operated. Choose **OFF** to disable control sounds.

Options			
 (high)	 (medium)	 (low)	 OFF (mute)

MSEF ELECTRONIC SHUTTER VOLUME

Adjust the volume of the sounds produced by the mechanical or electronic front-curtain shutter.

Options			
 (high)	 (medium)	 (low)	 OFF (mute)

MSEF ELECTRONIC SHUTTER SOUND

Choose the sound made by the mechanical or electronic front-curtain shutter.

Options		
 1 SOUND 1	 2 SOUND 2	 3 SOUND 3

ES ELECTRONIC SHUTTER VOLUME

Adjust the volume of the sounds produced by the electronic shutter. Choose **OFF** to disable the shutter sound.

Options

 (high)

 (medium)

 (low)

 **OFF** (mute)

ES ELECTRONIC SHUTTER SOUND

Choose the sound made by the electronic shutter.

Options

 **1 SOUND 1**

 **2 SOUND 2**

 **3 SOUND 3**

PLAYBACK VOLUME

Adjust the volume for movie playback.

Options

0

1

2

3

4

5

6

7

8

9

10

4ch AUDIO PLAYBACK

Adjust audio settings for use when viewing 4ch movies.

Option	Description
XLR	The camera plays audio recorded via external microphones connected via the XLR microphone adapter.
CAMERA	The camera plays audio recorded via the camera's built-in microphone or external microphones connected via the microphone jack.

 You can also switch sources while viewing the playback display by pressing the center of the focus stick (focus lever).

SCREEN SETTING

Make changes to display settings.

To access display settings, press **MENU/OK**, select the **SET UP** tab, and choose **SCREEN SET-UP**.

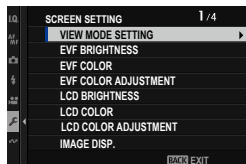

VIEW MODE SETTING

Adjust settings for eye sensor, EVF (electronic viewfinder), or LCD monitor view modes (18).

EVF BRIGHTNESS

Adjust the brightness of the display in the electronic viewfinder.

Option	Description
AUTO	The camera automatically adjusts brightness around a selected level in response to changes in ambient lighting conditions.
MANUAL	Adjust brightness manually; choose from options between -7 and +5.

EVF COLOR

Adjust the saturation of the display in the electronic viewfinder.

Options										
-5	-4	-3	-2	-1	0	+1	+2	+3	+4	+5

EVF COLOR ADJUSTMENT

Adjust the color of the display in the electronic viewfinder.

- 1 Adjust colors using the focus stick (focus lever).

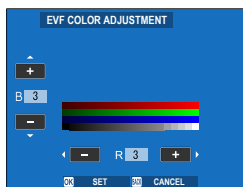

- 2 Press **MENU/OK**.

LCD BRIGHTNESS

Adjust monitor brightness.

Options										
-5	-4	-3	-2	-1	0	+1	+2	+3	+4	+5

LCD COLOR

Adjust monitor saturation.

Options										
-5	-4	-3	-2	-1	0	+1	+2	+3	+4	+5

LCD COLOR ADJUSTMENT

Adjust the color of the display in the LCD monitor.

- 1 Adjust colors using the focus stick (focus lever).
- 2 Press **MENU/OK**.

IMAGE DISP.

Choose how long images are displayed after shooting.

Option	Description
CONTINUOUS	Pictures are displayed until the MENU/OK button is pressed or the shutter button is pressed halfway. To zoom in on the active focus point, press the center of the focus stick (focus lever); press again to cancel zoom.
1.5 SEC	Pictures are displayed for the selected time or until the shutter button is pressed halfway.
0.5 SEC	
OFF	Pictures are not displayed after shooting.



- Colors may differ slightly from those in the final image.
- “Noise” mottling may be visible at high sensitivities.

AUTOROTATE DISPLAYS

Choose whether the indicators in the viewfinder and LCD monitor rotate to match camera orientation.

Options	
ON	OFF

PREVIEW EXP./WB IN MANUAL MODE

Choose whether to enable exposure and/or white balance preview in manual exposure mode.

Option	Description
PREVIEW EXP./WB	Enable exposure and white balance preview.
PREVIEW WB	Preview white balance only. Choose this option in situations in which exposure is likely to change during shooting, as may be the case when you use a flash during daylight.
OFF	Disable exposure and white balance preview. Choose this option in situations in which both exposure and white balance are likely to change during shooting, as may be the case when you use a flash with an incandescent monitoring lamp.

NATURAL LIVE VIEW

Choose whether the effects of film simulation, white balance, and other settings are visible in the monitor.

Option	Description
ON	The effects of camera settings are not visible in the monitor, but shadows in low-contrast, back-lit scenes and other hard-to-see subjects more visible. Colors and tone will differ from those in the final picture. The display will however be adjusted to show the effects of monochrome and sepia settings.
OFF	The effects of film simulation, white balance, and other settings can be previewed in the monitor.

F-Log VIEW ASSIST

Select **ON** to display a tone-corrected preview (equivalent to BT.709) when recording or viewing F-log movies.

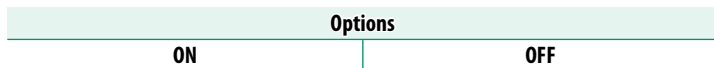



ELECTRONIC LEVEL SETTING

Adjust settings for use when taking pictures using the virtual horizon display (📖 25).

FRAMING GUIDELINE

Choose a framing grid for shooting mode.

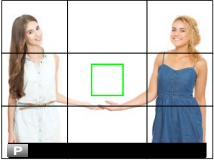
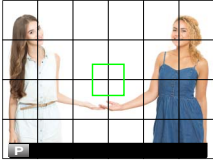
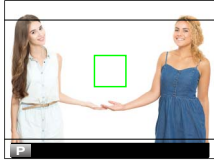
Option		
 GRID 9	 GRID 24	 HD FRAMING
 <p>Display</p>		
<p>For “rule of thirds” composition.</p>	<p>A six-by-four grid.</p>	<p>Frame HD pictures in the crop shown by the lines at the top and bottom of the display.</p>

 Framing guides are not shown at default settings but can be displayed using **SCREEN SET-UP > DISP. CUSTOM SETTING** (23).

AUTOROTATE PB

Choose **ON** to automatically rotate “tall” (portrait-orientation) pictures during playback.

Options	
ON	OFF

FOCUS SCALE UNITS

Choose the units used for the focus distance indicator.

Options	
METERS	FEET

APERTURE UNIT FOR CINEMA LENS

Choose whether the camera displays aperture as a T-number (used for movie camera lenses) or an f/-number (used for still camera lenses) when an optional FUJINON MKX-series lens is attached. For information on using cinema lenses, see the documentation provided with the lens.

Option	Description
T NUMBER	A measure of lens aperture commonly used by cinematographers. Lens transmittance is taken into account to better calculate exposure.
F NUMBER	A measure of lens aperture commonly used by photographers. Lens transmittance is assumed to be 100%, meaning that the same aperture may produce different exposures depending on the lens.

DUAL DISPLAY SETTING

Choose the content of the two windows in the dual display.

Option	Description
R:FOCUS L:FRAME	The right (small) window shows a close-up of the focus area, while the left (large) window shows the entire frame.
R:FRAME L:FOCUS	The right (small) window shows the entire frame, while the left (large) window shows a close-up of the focus area.

DISP. CUSTOM SETTING

Choose the items shown in the standard indicator display (📖 23).

LARGE INDICATORS MODE(EVF)

Select **ON** to display large indicators in the electronic viewfinder. The indicators displayed can be selected using **SCREEN SET-UP > LARGE INDICATORS DISP. SETTING**.



OFF



ON

Some icons are not displayed when **ON** is selected for **LARGE INDICATORS MODE(EVF)** (📖 15).

If **LARGE INDICATORS MODE** is assigned to a function button, the button can be used to toggle **LARGE INDICATORS MODE** on (**ON**) and off (**OFF**) (📖 297).

LARGE INDICATORS MODE(LCD)

Select **ON** to display large indicators in the LCD monitor. The indicators displayed can be selected using **SCREEN SET-UP > LARGE INDICATORS DISP. SETTING**.



OFF

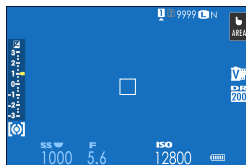

ON

Some icons are not displayed when **ON** is selected for **LARGE INDICATORS MODE(LCD)** (📖 17).

If **LARGE INDICATORS MODE** is assigned to a function button, the button can be used to toggle **LARGE INDICATORS MODE** on (**ON**) and off (**OFF**) (📖 297).

LARGE INDICATORS DISP. SETTING

Choose the indicators displayed when **ON** is selected for **SCREEN SET-UP > LARGE INDICATORS MODE(EVF)** or **LARGE INDICATORS MODE(LCD)**.

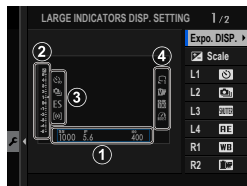

Option	Description
① Expo. DISP.	Choose the items listed at the bottom of the display. Selected items are indicated by check marks (☑); to deselect, highlight the check marks and press MENU/OK .
② Scale	Select ON to display the exposure indicator.
③ L1, L2, L3, L4	Choose up to four large icons for display on the left side of the screen.
④ R1, R2, R3, R4	Choose up to four large icons for display on the right side of the screen.

INFORMATION CONTRAST ADJ.

Adjust display contrast.

Option	Description
HIGH CONTRAST	High contrast.
STANDARD	Normal contrast.
LOW CONTRAST	Low contrast.
DARK AMBIENT LIGHTING	Contrast adjusted for dim ambient lighting.

LOCATION INFO

Select **ON** to display location info downloaded from a smart-phone.

Options	
ON	OFF

SUB MONITOR SETTING

Choose the indicators displayed in the secondary LCD monitor. Separate displays are available for still photography and movie recording.

- 1 Select **SCREEN SET-UP > SUB MONITOR SETTING** in the setup menu.
- 2 Highlight **STILL MODE** or **MOVIE MODE** and press **MENU/OK**.
- 3 Highlight the indicator you wish to change and press **MENU/OK**.

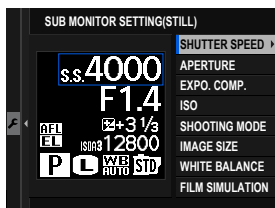

- 4 Highlight the indicator you wish to display and press **MENU/OK**.

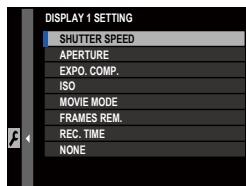

Choose from:

- SHUTTER SPEED
- APERTURE
- EXPO. COMP.
- ISO
- MOVIE MODE
- FRAMES REM.
- REC. TIME
- SHOOTING MODE
- PHOTOMETRY
- DRIVE MODE
- FOCUS MODE
- WHITE BALANCE
- IMAGE SIZE
- IMAGE QUALITY
- BATTERY LEVEL
- CARD SLOT OPTIONS
- SHUTTER TYPE
- FILM SIMULATION
- DYNAMIC RANGE
- CONNECTION STATUS
- NONE

- 5 Repeat Steps 3 and 4 to change additional indicators.

SUB MONITOR BACKGROUND COLOR

Adjusting the background color of the secondary LCD monitor according to lighting conditions makes the display easier to read.

Option	Description
BLACK	Recommended for use with dark ambient lighting.
WHITE	Recommended for use with bright ambient lighting.

 The background is displayed in white when the secondary LCD monitor backlight is on.

📷 Q MENU BACKGROUND

Choose the background color used for the quick menu when it is displayed during still photography.

Options	
TRANSPARENT	BLACK

🎥 Q MENU BACKGROUND

Choose the background color used for the quick menu when it is displayed during movie recording.

Options	
TRANSPARENT	BLACK

BUTTON/DIAL SETTING

Access options for camera controls.

To access control options, press **MENU/OK**, select the **SET UP** tab, and choose **BUTTON/DIAL SETTING**.

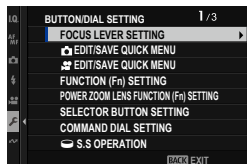

FOCUS LEVER SETTING

Choose the functions performed by pressing the center of the focus stick (focus lever) or by pressing the stick up, down, left, or right.

PUSH

Option	Description
OFF	Pressing the center of the stick has no effect.
EDIT FOCUS AREA	Press the center of the stick to choose the focus area size. If FACE/EYE DETECTION SETTING or SUBJECT DETECTION SETTING is on, you can instead position the focus frame over the desired face, eye, animal, or object.
ZOOM	Press the center of the stick to zoom in on the active focus area (99).
RESET TO CENTER	Press the center of the stick to select the center focus area.

TILT

Option	Description
OFF	Pressing the stick up, down, left, or right has no effect.
DIRECT AF POINT SELECTION	Choose the focus area without leaving the shooting display.
EDIT FOCUS AREA	Press the stick up, down, left, or right to view a focus-area display and choose the focus area.

EDIT/SAVE QUICK MENU

Choose the items displayed in the quick menu during still photography ( 291).

EDIT/SAVE QUICK MENU

Choose the items displayed in the quick menu when filming movies ( 291).

FUNCTION (Fn) SETTING

Choose the roles played by the function buttons ( 297).

POWER ZOOM LENS FUNCTION (Fn) SETTING

Choose the roles played by the function buttons available on some power zoom lenses ( 306).

SELECTOR BUTTON SETTING

Choose the roles played by the up, down, left, and right buttons on the selector.

Option	Description
Fn BUTTON	The selector buttons serve as function buttons.
FOCUS AREA	The selector buttons can be used to position the focus area.

 Selecting **FOCUS AREA** prevents you accessing the functions assigned to the function buttons.

COMMAND DIAL SETTING

Choose whether to reverse the roles played by the front and rear command dials in each of the following modes.

Option	Description
P	Reverse the dials used for program shift and exposure compensation in mode P (program AE).
S	Reverse the dials used for shutter-speed selection and exposure compensation in mode S (shutter-priority AE).
A	Reverse the dials used for aperture selection and exposure compensation in mode A (aperture-priority AE).
M	Reverse the dials used for shutter-speed and aperture selection in mode M (manual).

S.S OPERATION

Select **OFF** to disable shutter-speed fine-tuning using the command dials.

Options	
ON	OFF

COMMAND DIAL DIRECTION

Choose the direction in which the command dials are rotated to choose values. Settings for the front and rear command dials can be adjusted separately.

Option	Description
- ----- +	Rotate the dial right for higher values or to move to the next item.
+ ----- -	Rotate the dial left for higher values or to move to the next item.

SHUTTER AF

Choose whether the camera focuses when the shutter button is pressed halfway.

Option	Description
AF-S	<ul style="list-style-type: none"> • ON: Focus locks when the shutter button is pressed halfway. • OFF: No focus operation is performed when the shutter button is pressed halfway.
AF-C	<ul style="list-style-type: none"> • ON: The camera focuses while the shutter button is pressed halfway. • OFF: No focus operation is performed when the shutter button is pressed halfway.

SHUTTER AE

If **ON** is selected, exposure will lock while the shutter button is pressed halfway. The setting for focus mode **CONTINUOUS AF** (AF-C) can be adjusted separately from that for modes **SINGLE AF** (AF-S) and **MANUAL FOCUS**.

Options	
ON	OFF

 Select **OFF** to allow the camera to adjust exposure before each shot taken in burst mode.

SHOOT WITHOUT LENS

Choose **ON** to enable the shutter release when no lens is attached.

Options	
ON	OFF

SHOOT WITHOUT CARD

Choose whether the shutter can be released without a memory card inserted in the camera.



Option	Description
ON	When no memory card is inserted, the shutter can be released to test camera function and the shooting and setup menus can be displayed.
OFF	The shutter is disabled if no memory card is inserted, preventing accidental loss of pictures taken without a memory card.

LENS ZOOM/FOCUS SETTING

Adjust settings for compatible lenses with focus rings or power zoom.

FOCUS RING ROTATE

Choose the direction in which the focus ring is rotated to increase the focus distance.

Options	
 CW (clockwise)	 CCW (counterclockwise)

FOCUS RING OPERATION

Choose how the camera adjusts focus in response to the movement of the focus ring.

Option	Description
NONLINEAR	Focus is adjusted at the same rate as the ring is rotated.
LINEAR	Focus is adjusted linearly according to the amount the ring is rotated, but the focusing speed is unaffected by the speed the ring is rotated.

MF CONSTANT SPEED FOCUS (Fn)

Choose the rate at which the focus distance changes when adjusted using function buttons during manual focus with compatible power zoom lenses. The higher the number, the higher the rate.

Options							
1(SLOW)	2	3	4	5	6	7	8(FAST)

CONSTANT SPEED ZOOM (Fn)

Choose the rate at which compatible power zoom lenses can be zoomed in or out using function buttons. The higher the number, the higher the rate.

Options							
1(SLOW)	2	3	4	5	6	7	8(FAST)

CONSTANT SPEED ZOOM/FOCUS (Fn) OPERATION

Choose whether the function buttons on compatible power zoom lenses need only be pressed once to start and stop power focus or power zoom.

Option	Description
START/STOP SWITCH	The operation starts when the button is pressed and stops when it is pressed a second time.
ACTIVE WHILE PRESSING	The operation continues while the button is pressed and stops when the button is released.

ZOOM RING ROTATE

Choose whether to reverse the rotation of the zoom ring on compatible power zoom lenses.

Options	
 CW (clockwise)	 CCW (counterclockwise)

ZOOM/FOCUS CONTROL RING

Choose role played by the zoom/focus control ring on compatible power zoom lenses.

Options	
ZOOM	FOCUS

AE/AF-LOCK MODE

This option determines the behavior of the button to which exposure and/or focus lock is assigned.

Option	Description
AE&AF ON WHEN PRESSING	Exposure and/or focus will lock while the button is pressed.
AE&AF ON/OFF SWITCH	Exposure and/or focus will lock when the button is pressed and remain locked until it is pressed again.





AWB-LOCK MODE

Choose the behavior of function buttons assigned auto white balance (AWB) lock. Auto white balance lock is used to lock white balance at the value metered by the camera when **WB AUTO WHITE PRIORITY, AUTO,** or **AUTO AMBIENCE PRIORITY** is selected for white balance.

Option	Description
AWB ON WHEN PRESSING	Auto white balance locks while the button is pressed.
AWB ON/OFF SWITCH	Press the button once to lock auto white balance and again to end the lock.

▶ ISO BUTTON SETTING

Choose the role performed by the **ISO** button during playback.

Option	Description
 SMARTPHONE TRANSFER ORDER	Pressing the button displays a dialog where pictures can be selected for upload to a smartphone (📖 234).
 FTP TRANSFER ORDER	Pressing the button marks the current picture for upload to an FTP server.
 FTP PRIORITY TRANSFER ORDER	Pressing the button marks the current picture for priority upload to an FTP server. The picture will be moved to the head of the upload queue.
 WIRELESS COMMUNICATION	The button can be used for wireless connections.

 **FTP TRANSFER ORDER** and  **FTP PRIORITY TRANSFER ORDER** can only be used when an optional FT-XH file transmitter is connected.

TOUCH SCREEN SETTING

Enable or disable touch-screen controls.

TOUCH SCREEN SETTING

Option	Description
ON	The LCD monitor functions as a touch screen during shooting.
OFF	Touch controls disabled.

DOUBLE TAP SETTING

Option	Description
ON	Tap the LCD monitor twice to zoom in on your subject during shooting.
OFF	Touch zoom disabled.

TOUCH FUNCTION

Option	Description
ON	Enable touch-function gestures.
OFF	Disable touch-function gestures.

TOUCH ZOOM







Option	Description
ON	If the lens supports touch zoom, you can zoom in and out by touching the LCD monitor ( 35).
OFF	Touch zoom disabled.

▶ TOUCH SCREEN SETTING

Option	Description
ON	The LCD monitor functions as a touch screen during playback.
OFF	Touch controls disabled.

EVF TOUCH SCREEN AREA SETTINGS

Select the area of the LCD monitor used for touch controls while the viewfinder is active. The area used for touch controls can be selected from:

Option	Description
	All.
	Right half.
	Top right quarter.
	Bottom right quarter.
	Left half.
	Top left quarter.
	Bottom left quarter.
OFF	Touch controls disabled.

LOCK

Lock selected controls to prevent unintended operation.

Option	Description
LOCK SETTING	Choose from the following: <ul style="list-style-type: none"> • UNLOCK: Reset lock options. • ALL FUNCTION: Lock all controls in the FUNCTION SELECTION list. • SELECTED FUNCTION: Lock only the controls selected in the FUNCTION SELECTION list.
FUNCTION SELECTION	Choose the controls locked when SELECTED FUNCTION is chosen for LOCK SETTING .

 The controls selected using **SELECTED FUNCTION** can be locked at any time during shooting by pressing and holding **MENU/OK**. To unlock the controls, press and hold the button again.

POWER MANAGEMENT

Adjust power management settings.

To access power management settings, press **MENU/OK**, select the **SET UP** tab, and choose **POWER MANAGEMENT**.

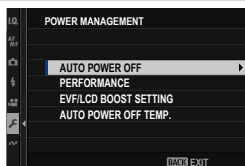

AUTO POWER OFF

Choose the length of time before the camera turns off automatically when no operations are performed. Shorter times increase battery life; if **OFF** is selected, the camera must be turned off manually.

Options					
5 MIN	2 MIN	1 MIN	30 SEC	15 SEC	OFF

PERFORMANCE

Select **BOOST** to improve focus and viewfinder display performance.

Option	Description
BOOST	Boost camera focus and viewfinder display performance. The battery drains faster than when is NORMAL selected.
NORMAL	Choose for standard focus and viewfinder display performance and battery endurance.
ECONOMY	Limit autofocus and viewfinder performance. This option offers better battery endurance than does NORMAL .

EVF/LCD BOOST SETTING

Adjust the behavior of the EVF and LCD monitor when **BOOST** is selected for **PERFORMANCE**.

Option	Description
EVF/LCD LOW LIGHT PRIORITY	Display brightness is adjusted to make subjects in shadows easier to see. Motion blur may cause ghosting.
EVF/LCD RESOLUTION PRIORITY	Display resolution is increased to make details easier to see.
EVF FRAME RATE PRIORITY (120P)	The refresh rate for the EVF is increased, smoothing motion.
EVF FRAME RATE PRIORITY (240P EQUIV.)	The refresh rate for the EVF is increased beyond EVF FRAME RATE PRIORITY (120P) smoothing motion still further. The EVF may darken.

AUTO POWER OFF TEMP.

If its temperature rises beyond a certain point, the camera will first display a message and then, if the temperature rise continues, automatically end shooting and power down. Choose the temperature at which the camera turns off automatically.

Option	Description
STANDARD	The camera turns off automatically when its temperature reaches the STANDARD value.
HIGH	Shooting can continue at temperatures higher than the STANDARD value, extending the time available to record movies and the like. Because remaining in contact with the camera at these high temperatures could result in low-temperature burns, this option should only be used after mounting the camera on a tripod or taking other steps to avoid prolonged contact with the camera.

SAVE DATA SETTING

Make changes to file management settings.

To access file management settings, press **MENU/OK**, select the **⌘ (SET UP)** tab, and choose **SAVE DATA SET-UP**.

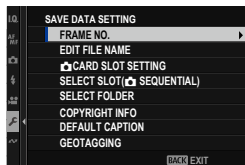

FRAME NO.

New pictures are stored in image files named using a four-digit file number assigned by adding one to the last file number used. The file number is displayed during playback as shown. **FRAME NO.** controls whether file numbering is reset to 0001 when a new memory card is inserted or the current memory card is formatted.

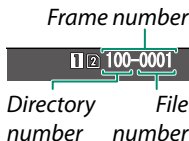

Option	Description
CONTINUOUS	Numbering continues from the last file number used or the first available file number, whichever is higher. Choose this option to reduce the number of pictures with duplicate file names.
RENEW	Numbering is reset to 0001 after formatting or when a new memory card is inserted.

- If the frame number reaches 999-9999, the shutter release will be disabled. Turn the camera off and insert a formatted memory card before resuming shooting.
- Selecting **⌘ USER SETTING > RESET** sets **FRAME NO.** to **CONTINUOUS** but does not reset the file number.
- Frame numbers for pictures taken with other cameras may differ.

EDIT FILE NAME

Change the file name prefix. sRGB images use a four-letter prefix (default “DSCF”), Adobe RGB images a three-letter prefix (“DSF”) preceded by an underscore.

Option	Default prefix	Sample file name
sRGB	DSCF	ABCD0001
AdobeRGB	_DSF	_ABC0001

📷 CARD SLOT SETTING

Choose the role played by the card in the second slot.

Option	Description
SEQUENTIAL	The card in the second slot is used only when the card in the first slot is full.
BACKUP	Each picture is recorded twice, once to each card.
SEPARATE	RAW pictures will be saved to the card in the first slot and JPEG or HEIF pictures to the card in the second slot. This option only takes effect when FINE+RAW or NORMAL+RAW is selected for  IMAGE QUALITY SETTING > IMAGE QUALITY .

SELECT SLOT(📷SEQUENTIAL)

Choose the card that is recorded to first when **SEQUENTIAL** is selected for  **CARD SLOT SETTING**.

Options	
SLOT 1	SLOT 2

SELECT FOLDER

Create folders and choose the folder used to store subsequent pictures.

Option	Description
SELECT FOLDER	To choose the folder in which subsequent pictures will be stored, press the focus stick (focus lever) up or down to highlight an existing folder and press MENU/OK .
CREATE FOLDER	Enter a five-character folder name. The new folder will be created with the next picture you take and subsequent pictures will be stored in that folder.

COPYRIGHT INFO

Copyright information, in the form of Exif tags, can be added to new images as they are taken. Changes to copyright information are reflected only in images taken after the changes are made.

Option	Description
DISP COPYRIGHT INFO	View the current copyright information.
ENTER AUTHOR'S INFO	Enter the creator's name.
ENTER COPYRIGHT INFO	Enter the name of the copyright holder.
DELETE COPYRIGHT INFO	Delete the current copyright information. This change applies only to images taken after this option is selected; copyright information recorded with existing images is not affected.

DEFAULT CAPTION

Choose the caption applied to new photos and movies.

DISPLAY

View the current caption.

EDIT

Enter a caption.

ERASE

Delete the current caption.

GEOTAGGING

If **ON** is selected, location data downloaded from a smartphone will be embedded in pictures as they are taken.

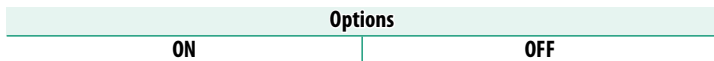

10

Shortcuts

Shortcut Options

Customize camera controls to suit your style or situation.

Frequently-used options can be added to the Q menu or a custom “my” menu or assigned to a function button or touch-function gesture for direct access:

Shortcut Option	Description	
“My menu”	Add frequently-used options to this custom menu, which can be viewed by pressing MENU/OK and selecting the MY (“MY MENU”) tab.	289
The Quick Menu	The Q menu is displayed by pressing the Q button. Use the Q menu to view or change the options selected for frequently-used menu items.	291
The function buttons	Use the function buttons for direct access to selected features.	297
Touch-function gestures	Use touch function button flick gestures (T-Fn1 , T-Fn2 , T-Fn3 , and T-Fn4) for direct access to selected features.	303
Lens function buttons	Use the function buttons on the lens (if any) for direct access to selected features.	306

MY MENU

Access a personalized menu of frequently-used options.

To display “my menu”, press **MENU/OK** in the shooting display and select the **MY** (**MY MENU**) tab.

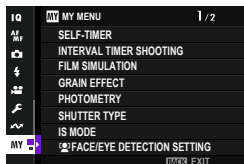

❗ The **MY** tab is only available if options have been assigned to **MY MENU**.

MY MENU SETTING

To choose the items listed in the **MY** (**MY MENU**) tab:

- 1 In the setup menu, select **USER SETTING > MY MENU SETTING** or **MY MENU SETTING**.

📁 To reorder items, select **RANK ITEMS**.
To delete items, select **REMOVE ITEMS**.

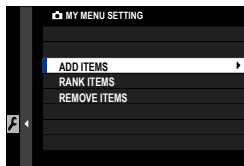

- 2 Press the focus stick (focus lever) up or down to highlight **ADD ITEMS** and press **MENU/OK**. Options that can be added to “my menu” are highlighted in blue.

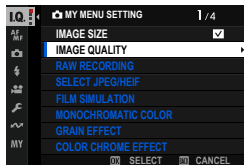

📁 Items currently in “my menu” are indicated by check marks.

- 3 Choose a position for the item and press **MENU/OK**. The item will be added to “my menu”.

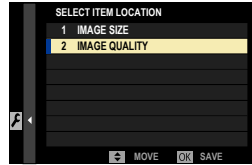

- 4 Press **MENU/OK** to return to the edit display.
- 5 Repeat Steps 3 and 4 until all the desired items have been added.

 “My menu” can contain up to 16 items.

The Quick Menu

Use the quick menu for quick access to selected options. To view the quick menu, press the **Q** button.

The Quick Menu Display

The quick menu offers different options in photo and movie modes. At default settings, it contains the following items:

Still photography

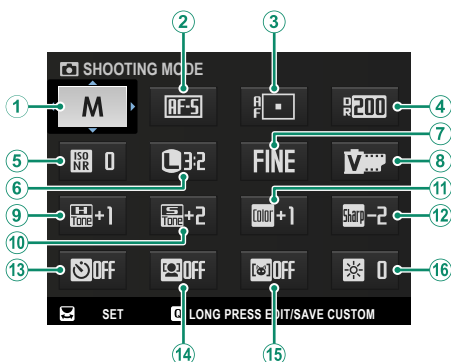

Default





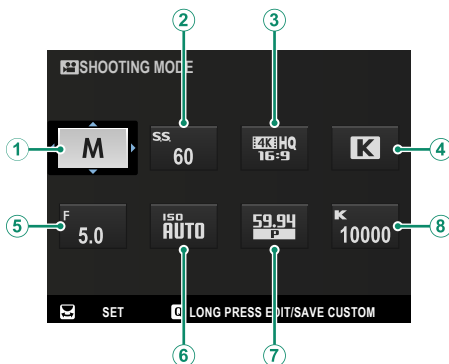

① SHOOTING MODE	⑨ HIGHLIGHT TONE
② FOCUS MODE	⑩ SHADOW TONE
③ AF MODE	⑪ COLOR
④ DYNAMIC RANGE	⑫ SHARPNESS
⑤ HIGH ISO NR	⑬ SELF-TIMER
⑥ IMAGE SIZE	⑭ FACE/EYE DETECTION SETTING
⑦ IMAGE QUALITY	⑮ SUBJECT DETECTION SETTING
⑧ FILM SIMULATION	⑯ EVF/LCD BRIGHTNESS

The quick menu shows the options currently selected for items ②–⑯, which can be changed.

Movie recording



Default

① SHOOTING MODE	⑤ APERTURE (MOVIE OPTIMIZED CONTROL  )
② SHUTTER SPEED	⑥  ISO
③ MOVIE MODE RESOLUTION/ ASPECT RATIO	⑦ MOVIE MODE FRAME RATE
④  WHITE BALANCE	⑧  WHITE BALANCE COLOR TEMP. (WHEN  SELECTED)

The quick menu shows the options currently selected for items ②–⑧, which can be changed.

Viewing and Changing Settings

- 1 Press **Q** to display the quick menu during shooting.

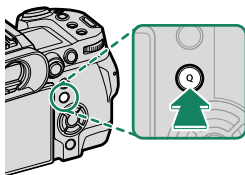

- 2 Use the focus stick (focus lever) to highlight items and rotate the rear command dial to change.

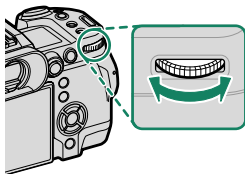

To jump to the **EDIT/SAVE CUSTOM SETTING** or **EDIT/SAVE CUSTOM SETTING** menu, press and hold the **Q** button when the quick menu is displayed.

- 3 Press **Q** to exit when settings are complete.

- The quick menu can also be edited using touch controls.
- Using **BUTTON/DIAL SETTING > FUNCTION (Fn) SETTING**, you can assign the **Q** button roles normally reserved for the function buttons or assign the **Q** button's default role to a function button (📖 297).
- To disable the **Q** (quick menu) button, select **NONE** for **BUTTON/DIAL SETTING > FUNCTION (Fn) SETTING > Q BUTTON SETTING**.

Editing the Quick Menu



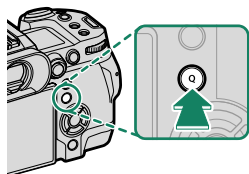

To choose the items displayed in the quick menu:

- 1 Press and hold the **Q** button during shooting.







 The camera displays the photo quick menu during still photography and the movie quick menu when in movie mode.

- 2 The current quick menu will be displayed; use the focus stick (focus lever) to highlight the item you wish to change and press **MENU/OK**.
- 3 Highlight the item you wish to change and press **MENU/OK**. The following can be assigned to the quick menu.

 The quick menus can also be edited using  **BUTTON/DIAL SETTING >**  **EDIT/SAVE QUICK MENU** or  **EDIT/SAVE QUICK MENU**.







Available Items (Still Photography)

Choose from:

- IMAGE SIZE
- IMAGE QUALITY
- FILM SIMULATION
- GRAIN EFFECT
- COLOR CHROME EFFECT
- COLOR CHROME FX BLUE
- SMOOTH SKIN EFFECT
- DYNAMIC RANGE
- D RANGE PRIORITY
- WHITE BALANCE
- WHITE BALANCE COLOR TEMP.
(WHEN  SELECTED)
- HIGHLIGHT TONE
- SHADOW TONE
- COLOR
- SHARPNESS
- CLARITY
- HIGH ISO NR
- FOCUS MODE
- AF MODE
- AF-C CUSTOM SETTINGS
-  FACE/EYE DETECTION SETTING
- SUBJECT DETECTION SETTING
- MF ASSIST
- TOUCH SCREEN MODE
- SELF-TIMER
- PHOTOMETRY
- SHUTTER TYPE
- FLICKER REDUCTION
- ISO
- FLASH FUNCTION SETTING
- FLASH COMPENSATION
- MOVIE MODE RESOLUTION/ASPECT RATIO
- MOVIE MODE FRAME RATE
- BIT RATE
- HIGH SPEED REC
-  IS MODE
-  IS MODE BOOST
- INTERNAL/EXTERNAL MIC LEVEL ADJUSTMENT
- EVF/LCD BRIGHTNESS
- EVF/LCD COLOR
- NONE

 To disable the function button, choose **NONE**.

Available Items (Movies)

- FILM SIMULATION
- DYNAMIC RANGE
-  WHITE BALANCE
-  WHITE BALANCE COLOR TEMP.
(WHEN  SELECTED)
- HIGHLIGHT TONE
- SHADOW TONE
- COLOR
- SHARPNESS
- HIGH ISO NR
-  FACE/EYE DETECTION SETTING
- SUBJECT DETECTION SETTING
- MF ASSIST
- TOUCH SCREEN MODE
- PHOTOMETRY
- MOVIE ISO
- MOVIE MODE RESOLUTION/ASPECT RATIO
- MOVIE MODE FRAME RATE
- BIT RATE
- HIGH SPEED REC
- FOCUS MODE
- MOVIE AF MODE
- FIX MOVIE CROP MAGNIFICATION
-  IS MODE
-  IS MODE BOOST
- SHUTTER SPEED
- APERTURE
(MOVIE OPTIMIZED CONTROL )
- INTERNAL/EXTERNAL MIC LEVEL ADJUSTMENT
- EVF/LCD BRIGHTNESS
- EVF/LCD COLOR
- NONE

 To disable the function button, choose **NONE**.

Function Controls

Assign a role to each function button or touch-function gesture for quick access to the selected feature.

The Function Buttons

Assign a role to the function buttons for quick access to the selected feature.

Function Button Defaults

The default assignments are:

Back-of-Camera Function Buttons

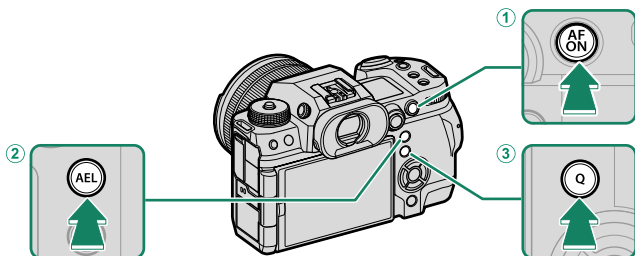

Function buttons	Default
① AFON button	AF-ON
② AEL (exposure lock) button	AE LOCK ONLY
③ Q (quick menu) button	QUICK MENU

Front-of-Camera Function Buttons

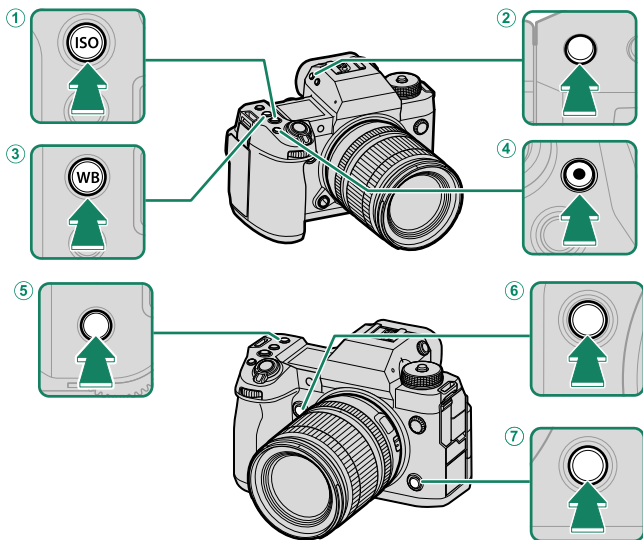

Function buttons	Default
① ISO button	ISO
② VIEW MODE button	VIEW MODE SETTING
③ WB button	WHITE BALANCE
④ ● (movie recording) button	MOVIE RECORDING RELEASE
⑤ Fn1 button	FACE DETECTION ON/OFF
⑥ Fn2 button	ELECTRONIC LEVEL SWITCH
⑦ Fn3 button	FOCUS MODE

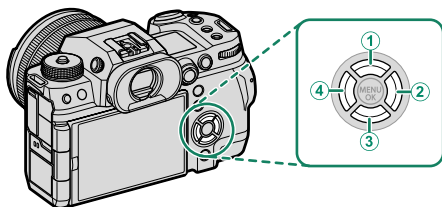

The Selector



Function buttons	Default
① Fn4 button	PHOTOMETRY
② Fn6 button	📷 DIGITAL TELE-CONV./📺 DIGITAL ZOOM
③ Fn7 button	PERFORMANCE
④ Fn5 button	FILM SIMULATION

Assigning Roles to the Function Buttons

The roles played by the function buttons can be selected using the  **BUTTON/DIAL SETTING > FUNCTION (Fn) SETTING** option in the setup menu.

-  WHEN SET TO **M** (ON/OFF SWITCH)
- IMAGE SIZE
- IMAGE QUALITY
- RAW
- FILM SIMULATION
- GRAIN EFFECT
- COLOR CHROME EFFECT
- COLOR CHROME FX BLUE
- SMOOTH SKIN EFFECT
- DYNAMIC RANGE
- D RANGE PRIORITY
- WHITE BALANCE
- CLARITY
- RECALL CUSTOM 1 SETTING
- FOCUS AREA
- FOCUS CHECK
- FOCUS MODE
- AF MODE
- AF-C CUSTOM SETTINGS
- FACE DETECTION ON/OFF
- RIGHT/LEFT EYE SWITCH
- SUBJECT DETECTION ON/OFF
- AF RANGE LIMITER
- FOCUS CHECK LOCK
- SPORTS FINDER MODE
- PRE-SHOT 
- SELF-TIMER
- AE BKT SETTING
- FOCUS BKT SETTING
- PHOTOMETRY
- SHUTTER TYPE
- FLICKER REDUCTION
- FLICKERLESS S.S. SETTING
- ISO
- IS MODE
-  DIGITAL TELE-CONV./
 DIGITAL ZOOM
- WIRELESS COMMUNICATION
- FLASH FUNCTION SETTING
- TTL-LOCK
- MODELING FLASH
- MOVIE RECORDING RELEASE
- HIGH SPEED REC
- FIX MOVIE CROP MAGNIFICATION
-  IS MODE BOOST
- ZEBRA SETTING
- COOLING FAN SETTING
- INTERNAL/EXTERNAL MIC LEVEL ADJUSTMENT
- 4ch AUDIO PLAYBACK
- MOVIE OPTIMIZED CONTROL 
- VIEW MODE SETTING
- EVF/LCD SWITCH
- PREVIEW DEPTH OF FIELD
- PREVIEW EXP./WB IN MANUAL MODE
- NATURAL LIVE VIEW
- HISTOGRAM
- ELECTRONIC LEVEL SWITCH
- LARGE INDICATORS MODE
- F-Log VIEW ASSIST
- COMMAND DIAL LOCK

- ZOOM/FOCUS CONTROL RING
- CONSTANT SPEED ZOOM (T)
- CONSTANT SPEED ZOOM (W)
- **MF** CONSTANT SPEED FOCUS (N)
- **MF** CONSTANT SPEED FOCUS (F)
- AE LOCK ONLY
- AF LOCK ONLY
- AE/AF LOCK
- AF-ON
- AWB LOCK ONLY
- LOCK SETTING
- PERFORMANCE
- AUTO IMAGE TRANSFER ORDER
- Bluetooth ON/OFF
- QUICK MENU
- PLAYBACK
- NONE



To disable the function button, choose **NONE**.

AF-ON

Controls to which **AF-ON** is assigned can be used for autofocus.

MODELING FLASH

If **MODELING FLASH** is selected when a compatible shoe-mounted flash unit is attached, you can press the control to test-fire the flash and check for shadows and the like (modeling flash).

TTL-LOCK



If **TTL-LOCK** is selected, you can press the control to lock flash output according to the option selected for **FLASH SETTING > TTL-LOCK MODE** (📖 178).

RECALL CUSTOM 1 SETTING

Controls to which **RECALL CUSTOM 1 SETTING** has been assigned can be pressed to temporarily recall the settings saved to position **C1** (CUSTOM 1) on the mode dial. Pressing the button a second time restores the previous settings.

Touch-Function Gestures

Assign roles to touch-function gestures (**T-Fn1**, **T-Fn2**, **T-Fn3**, or **T-Fn4**) for quick access to selected features.

 Touch-function gestures are disabled by default. To enable touch-function gestures, select **ON** for  **BUTTON/DIAL SETTING > TOUCH SCREEN SETTING >  TOUCH FUNCTION**.

Touch-Function Gesture Defaults



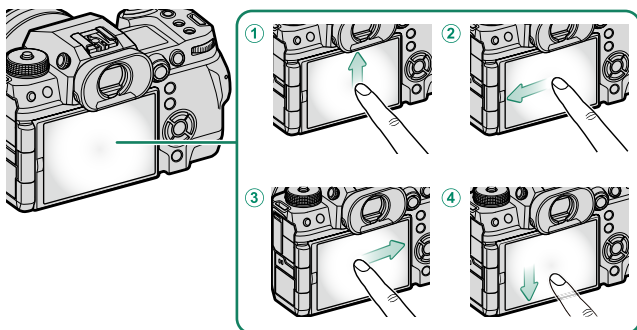

The default assignments for the different gestures are:



Touch-Function Gestures	Default
① T-Fn1 (flick up)	HISTOGRAM
② T-Fn2 (flick left)	PREVIEW DEPTH OF FIELD
③ T-Fn3 (flick right)	LARGE INDICATORS MODE
④ T-Fn4 (flick down)	ZEBRA SETTING

Assigning Roles to Touch-Function Gestures

The roles played by touch-function gestures can be selected using the  **BUTTON/DIAL SETTING > FUNCTION (Fn) SETTING** option in the setup menu.

- IMAGE SIZE
- IMAGE QUALITY
- RAW
- FILM SIMULATION
- GRAIN EFFECT
- COLOR CHROME EFFECT
- COLOR CHROME FX BLUE
- SMOOTH SKIN EFFECT
- DYNAMIC RANGE
- D RANGE PRIORITY
- WHITE BALANCE
- CLARITY
- RECALL CUSTOM 1 SETTING
- FOCUS AREA
- FOCUS CHECK
- FOCUS MODE
- AF MODE
- AF-C CUSTOM SETTINGS
- FACE DETECTION ON/OFF
- RIGHT/LEFT EYE SWITCH
- SUBJECT DETECTION ON/OFF
- AF RANGE LIMITER
- FOCUS CHECK LOCK
- SPORTS FINDER MODE
- PRE-SHOT 
- SELF-TIMER
- AE BKT SETTING
- FOCUS BKT SETTING
- PHOTOMETRY
- SHUTTER TYPE
- FLICKER REDUCTION
- FLICKERLESS S.S. SETTING
- ISO
- IS MODE
-  DIGITAL TELE-CONV./
 DIGITAL ZOOM
- WIRELESS COMMUNICATION
- FLASH FUNCTION SETTING
- TTL-LOCK
- MODELING FLASH
- HIGH SPEED REC
- FIX MOVIE CROP MAGNIFICATION
-  IS MODE BOOST
- ZEBRA SETTING
- COOLING FAN SETTING
- INTERNAL/EXTERNAL MIC LEVEL ADJUSTMENT
- 4ch AUDIO PLAYBACK
- MOVIE OPTIMIZED CONTROL 
- VIEW MODE SETTING
- EVF/LCD SWITCH
- PREVIEW DEPTH OF FIELD
- PREVIEW EXP./WB IN MANUAL MODE
- NATURAL LIVE VIEW
- HISTOGRAM
- ELECTRONIC LEVEL SWITCH
- LARGE INDICATORS MODE
- F-Log VIEW ASSIST
- COMMAND DIAL LOCK
- ZOOM/FOCUS CONTROL RING
- LOCK SETTING
- PERFORMANCE
- AUTO IMAGE TRANSFER ORDER

- Bluetooth ON/OFF
- QUICK MENU
- PLAYBACK
- NONE

 To disable touch-function gestures, choose **NONE**.

Lens Function Buttons

Choose the roles played by the function buttons on the lens (where applicable).

Lens Function Button Defaults

The default assignments are:



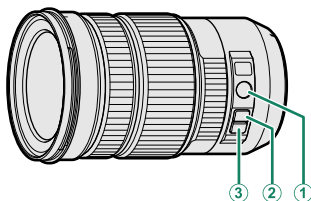

 A XF18-120mmF4 LM PZ WR lens is used here for illustrative purposes.



Lens function button	Default
① Z/F	ZOOM/FOCUS CONTROL RING
② L-Fn1 (rocker zoom button pressed up)	CONSTANT SPEED ZOOM (T)
③ L-Fn2 (rocker zoom button pressed down)	CONSTANT SPEED ZOOM (W)

Assigning Roles to the Lens Function Buttons

The roles played by the lens function buttons can be selected using the **FUNCTION/DIAL SETTING > POWER ZOOM LENS FUNCTION (Fn) SETTING** option in the setup menu.

- WHEN SET TO **M** (ON/OFF SWITCH)
- IMAGE SIZE
- IMAGE QUALITY
- RAW
- FILM SIMULATION
- GRAIN EFFECT
- COLOR CHROME EFFECT
- COLOR CHROME FX BLUE
- SMOOTH SKIN EFFECT
- DYNAMIC RANGE
- D RANGE PRIORITY
- WHITE BALANCE
- CLARITY
- RECALL CUSTOM 1 SETTING
- FOCUS AREA
- FOCUS CHECK
- FOCUS MODE
- AF MODE
- AF-C CUSTOM SETTINGS
- FACE DETECTION ON/OFF
- RIGHT/LEFT EYE SWITCH
- SUBJECT DETECTION ON/OFF
- AF RANGE LIMITER
- FOCUS CHECK LOCK
- SPORTS FINDER MODE
- PRE-SHOT **ES** 
- SELF-TIMER
- AE BKT SETTING
- FOCUS BKT SETTING
- PHOTOMETRY
- SHUTTER TYPE
- FLICKER REDUCTION
- FLICKERLESS S.S. SETTING
- ISO
- IS MODE
-  DIGITAL TELE-CONV./
 DIGITAL ZOOM
- WIRELESS COMMUNICATION
- FLASH FUNCTION SETTING
- TTL-LOCK
- MODELING FLASH
- MOVIE RECORDING RELEASE
- HIGH SPEED REC
- FIX MOVIE CROP MAGNIFICATION
-  IS MODE BOOST
- ZEBRA SETTING
- COOLING FAN SETTING
- INTERNAL/EXTERNAL MIC LEVEL ADJUSTMENT
- 4ch AUDIO PLAYBACK
- MOVIE OPTIMIZED CONTROL 
- VIEW MODE SETTING
- EVF/LCD SWITCH
- PREVIEW DEPTH OF FIELD
- PREVIEW EXP./WB IN MANUAL MODE
- NATURAL LIVE VIEW
- HISTOGRAM
- ELECTRONIC LEVEL SWITCH
- LARGE INDICATORS MODE
- F-Log VIEW ASSIST
- COMMAND DIAL LOCK

- ZOOM/FOCUS CONTROL RING
- CONSTANT SPEED ZOOM (T)
- CONSTANT SPEED ZOOM (W)
- **MF** CONSTANT SPEED FOCUS (N)
- **MF** CONSTANT SPEED FOCUS (F)
- AE LOCK ONLY
- AF LOCK ONLY
- AE/AF LOCK
- AF-ON
- AWB LOCK ONLY
- LOCK SETTING
- PERFORMANCE
- AUTO IMAGE TRANSFER ORDER
- Bluetooth ON/OFF
- QUICK MENU
- PLAYBACK
- NONE



- To disable the function button, choose **NONE**.
- Selected function lock is not available when **CONSTANT SPEED ZOOM (T)** or **CONSTANT SPEED ZOOM (W)** is assigned to a lens function button (📖 280).

11 Peripherals and Optional Accessories

Lenses

The camera can be used with lenses for the FUJIFILM X-mount.

Lens Parts

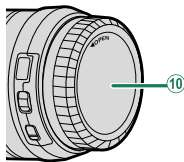
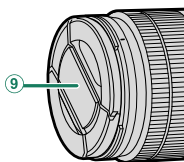
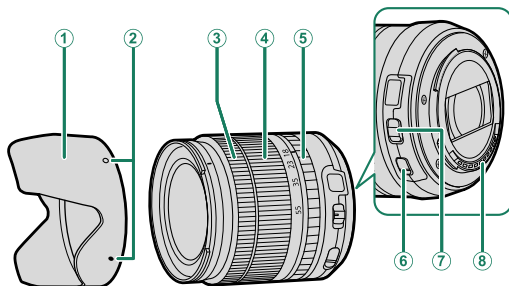

- ① Lens hood
- ② Mounting marks
- ③ Focus ring
- ④ Zoom ring
- ⑤ Aperture ring

- ⑥ O.I.S. switch
- ⑦ Aperture mode switch
- ⑧ Lens signal contacts
- ⑨ Front lens cap
- ⑩ Rear lens cap

 A XF18-55mmF2.8-4 R LM OIS lens is used here for illustrative purposes.

Lens Care

- Use a blower to remove dust, then gently wipe with a soft, dry cloth. Any remaining stains can be removed by wiping gently with a piece of Fujifilm lens-cleaning paper to which a small amount of lens-cleaning fluid has been applied.
- Replace the front and rear caps when the lens is not in use.

Removing Lens Caps

Remove lens caps as shown.

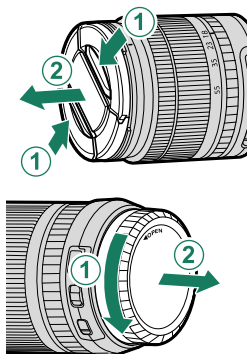

⚠ Lens caps may differ from those shown.

Attaching Lens Hoods

When attached, lens hoods reduce glare and protect the front lens element.

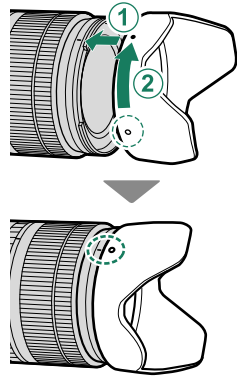

Lenses with Aperture Rings

At settings other than **A**, you can adjust aperture by rotating the lens aperture ring (exposure modes **A** and **M**).

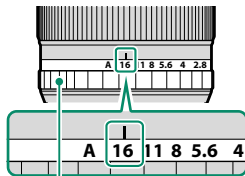

Aperture ring

- Selecting **ON** for **MOVIE OPTIMIZED CONTROL**  disables the aperture ring.
- When the aperture ring is set to **A**, rotate the command dials to adjust aperture.

The Aperture Mode Switch

If the lens has an aperture mode switch, aperture can be adjusted manually by sliding the switch to  and rotating the aperture ring.

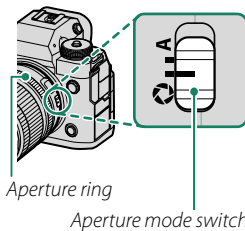

Aperture ring

Aperture mode switch

Lenses with No Aperture Rings

Aperture can be adjusted using the front command dial in modes **A** (aperture-priority AE) and **M** (manual).

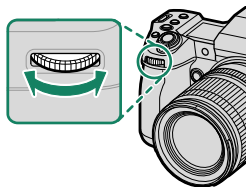

Aperture control can be reassigned to the rear command dial using **FUNCTION BUTTON/DIAL SETTING > COMMAND DIAL SETTING**.

Lenses with O.I.S. Switches

If the lens supports optical image stabilization (O.I.S.), the image stabilization mode can be chosen in the camera menus. To activate image stabilization, slide the O.I.S. switch to **ON**.

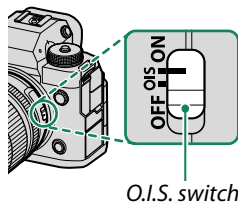

Manual Focus Lenses

Slide the focus ring to the front for auto-focus.

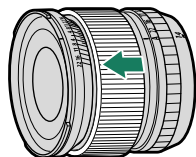

For manual focus, slide the focus ring to the back and rotate it while checking the results in the camera display. The focus distance and depth-of-field indicators can be used to assist manual focus.

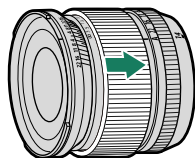

! Note that manual focus may not be available in all shooting modes.

The Depth-of-Field Indicator

The depth-of-field indicator shows the approximate depth of field (the distance in front of and behind the focus point that appears to be in focus). The indicator is displayed in film format.

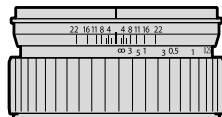

Power Zoom Lenses

Zoom can be adjusted on power zoom lenses using the zoom/focus control ring, zoom button, or zoom ring.

ⓘ Adjusting zoom while the lens is wet makes it easier for water to find its way inside the lens. Wipe any water from the lens before adjusting zoom.

📷 A XF18-120mmF4 LM PZ WR lens is used here for illustrative purposes.

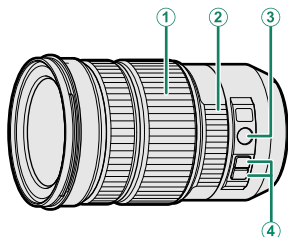

Control	Description
① Zoom ring	Rotate the zoom ring to zoom in or out manually.
② Zoom/focus control ring	Rotate the zoom/focus control ring to zoom in or out using powered zoom. The zoom speed is proportional to the speed with which the ring is rotated.
③ Z/F (zoom/focus) button	Switch the role of zoom/focus control ring from focus to zoom or <i>vice versa</i> .
④ Zoom buttons	Press a zoom button to zoom in or out at a steady speed using powered zoom. Zoom ends when the button is pressed a second time.



- 📷 • The **Z/F** and zoom buttons can be assigned other roles using **📷 BUTTON/DIAL SETTING > POWER ZOOM LENS FUNCTION (Fn) SETTING**.
- The speed at which zoom can be adjusted via the zoom buttons can be chosen using **📷 BUTTON/DIAL SETTING > LENS ZOOM/FOCUS SETTING**.

External Flash Units

Use optional external flash units for flash photography. Some units support high-speed sync (FP) and can be used at shutter speeds faster than the flash sync speed, while others can function as commanders controlling remote units via optical wireless flash control.

 You may be unable to test-fire the flash in some circumstances, for example when a setup menu is displayed on the camera.

Red-Eye Removal

Red-eye removal is available when an option other than **OFF** is selected for  **FLASH SETTING > RED EYE REMOVAL** and  **AF/MF SETTING >  FACE/EYE DETECTION SETTING** is **FACE DETECTION ON**. Red-eye removal minimizes “red-eye” caused when light from the flash is reflected from the subject’s retinas.

Flash Sync Speed

The flash will synchronize with the shutter at shutter speeds of $\frac{1}{250}$ s or slower.

Optional Flash Units from Fujifilm

The camera can be used with optional Fujifilm shoe-mounted flash units.

Third-Party Flash Units

Do not use third-party flash units that apply over 300 V to the camera hot shoe.

Flash Settings

- 1 Connect the unit to the camera.
- 2 In shooting mode, select **FLASH FUNCTION SETTING** in the **FLASH SETTING** menu tab. The options available vary with the flash unit.

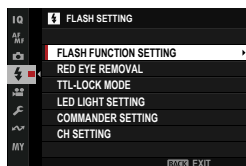

Menu	Description	
EF-X8	Displayed when an optional EF-X8 flash unit is mounted on the hot shoe and raised.	319
SYNC TERMINAL	Adjust settings for flash units connected via the sync terminal. SYNC TERMINAL is displayed if the EF-X8 is lowered and either no flash unit, or an incompatible flash unit, is mounted on the hot shoe.	321
SHOE MOUNT FLASH	Displayed when an optional flash unit other than the EF-X8 is mounted on the hot shoe and turned on.	322
COMMANDER (OPTICAL)	Displayed if an optional flash unit functioning as a commander for Fujifilm optical wireless remote flash control is connected and turned on.	325

- 3 Highlight items using the focus stick (focus lever) and rotate the rear command dial to change the highlighted setting.

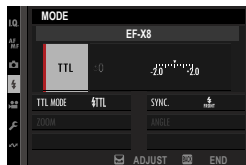



- 4 Press **DISP/BACK** to put the changes into effect.

EF-X8

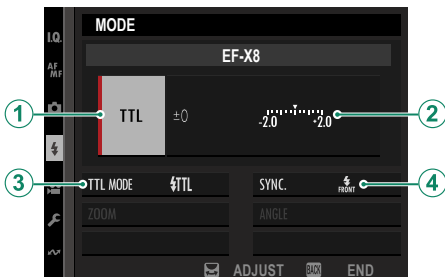
The following settings are available when an optional EF-X8 shoe-mounted flash unit is attached.



Setting	Description
① Flash control mode	<p>Choose from the following options:</p> <ul style="list-style-type: none"> • TTL: TTL mode. Adjust flash compensation (②) and choose a flash mode (③). • M: The flash fires at the selected output (②) regardless of subject brightness or camera settings. Output is expressed in fractions of full power, from $\frac{1}{4}$ to $\frac{1}{64}$. The desired results may not be achieved at low values if they exceed the limits of the flash control system; take a test shot and check the results. • COMMANDER: Choose if the flash is being used to control remote synced flash units, for example as part of a studio flash system. • OFF (OFF): The EF-X8 does not fire. Flash units connected via the sync terminal will still fire when the shutter is released, but can be disabled by lowering the EF-X8 and turning the units off in the flash settings menu.
② Flash compensation/output	Adjust flash level. The options available vary with the flash control mode (①).

Setting	Description
<p>③ Flash mode (TTL)</p>	<p>Choose a flash mode for TTL flash control. The options available vary with the shooting mode (P, S, A, or M) selected.</p> <ul style="list-style-type: none"> • FLASH AUTO: The flash fires only as required; flash level is adjusted according to subject brightness. A  icon displayed when the shutter button is pressed halfway indicates that the flash will fire when the photo is taken. • TTL (STANDARD): The flash fires with every shot if possible; flash level is adjusted according to subject brightness. The flash will not fire if not fully charged when the shutter is released. • TTL (SLOW SYNC.): Combine the flash with slow shutter speeds when photographing portrait subjects against a backdrop of night scenery. The flash will not fire if not fully charged when the shutter is released.
<p>④ Sync</p>	<p>Choose whether the flash is timed to fire immediately after the shutter opens (/1ST CURTAIN) or immediately before it closes (/2ND CURTAIN). 1ST CURTAIN is recommended in most circumstances.</p>

SYNC TERMINAL

The following options are available when no compatible flash unit is connected or if a unit is connected via the sync terminal or uses only the X-contact on the hot shoe.

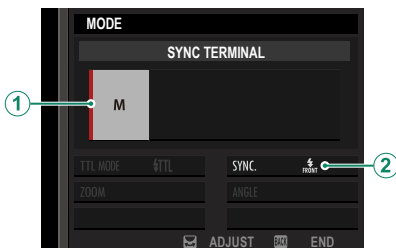

Setting	Description
① Flash control mode	<p>Choose from the following options:</p> <ul style="list-style-type: none"> • M: A trigger signal is transmitted via the hot shoe X contacts when a picture is taken. Choose a shutter speed slower than the sync speed; even slower speeds may be required if the unit uses long flashes or has a slow response time. • OFF (OFF): The trigger signal is disabled.
② Sync	<p>Choose whether the flash is timed to fire immediately after the shutter opens ($\frac{1}{2}$ FRONT / 1ST CURTAIN) or immediately before it closes ($\frac{1}{2}$ REAR / 2ND CURTAIN). 1ST CURTAIN is recommended in most circumstances.</p>

The Sync Terminal

Use the sync terminal to connect flash units that require a sync cable.

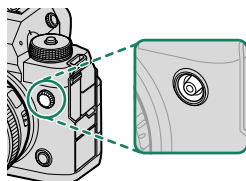





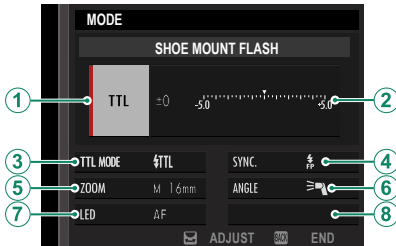



SHOE MOUNT FLASH

The following options are available when an optional shoe-mounted flash unit is attached and turned on.



Setting	Description
① Flash control mode	<p>The flash control mode selected with the flash unit. This can in some cases be adjusted from the camera; the options available vary with the flash.</p> <ul style="list-style-type: none"> • TTL: TTL mode. Adjust flash compensation (②). • M: The flash fires at the selected output regardless of subject brightness or camera settings. Output in some cases can be adjusted from the camera (②). • MULTI: Repeating flash. Compatible shoe-mounted flash units will fire multiple times with each shot. • OFF (OFF): The flash does not fire. Some flash units can be turned off from the camera.

Setting	Description
② Flash compensation/ output	<p>The options available vary with flash control mode.</p> <ul style="list-style-type: none"> • TTL: Adjust flash compensation (the full value may not be applied if the limits of the flash control system are exceeded). In the cases of the EF-X20, EF-20, and EF-42, the selected value is added to the value selected with the flash unit. • M/MULTI: Adjust flash output (compatible units only). Choose from values expressed as fractions of full power, from 1/4 (mode M) or 1/4 (MULTI) down to 1/512 in increments equivalent to 1/3 EV. The desired results may not be achieved at low values if they exceed the limits of the flash control system; take a test shot and check the results.
③ Flash mode (TTL)	<p>Choose a flash mode for TTL flash control. The options available vary with the shooting mode (P, S, A, or M) selected.</p> <ul style="list-style-type: none"> • FLASH AUTO: The flash fires only as required; flash level is adjusted according to subject brightness. A  icon displayed when the shutter button is pressed halfway indicates that the flash will fire when the photo is taken. • STANDARD: The flash fires with every shot if possible; flash level is adjusted according to subject brightness. The flash will not fire if not fully charged when the shutter is released. • SLOW SYNC.: Combine the flash with slow shutter speeds when photographing portrait subjects against a backdrop of night scenery. The flash will not fire if not fully charged when the shutter is released.

Setting	Description
④ Sync	Control flash timing. <ul style="list-style-type: none"> •  (1ST CURTAIN): The flash fires immediately after the shutter opens (generally the best choice). •  (2ND CURTAIN): The flash fires immediately before the shutter closes. •  (AUTO FP(HSS)): High-speed sync (compatible units only). The camera automatically engages front-curtain high-speed sync at shutter speeds faster than the flash sync speed. Equivalent to 1ST CURTAIN when MULTI is selected for flash control mode.
⑤ Zoom	The angle of illumination (flash coverage) for units that support flash zoom. Some units allow the adjustment to be made from the camera. If AUTO is selected, zoom will automatically be adjusted to match coverage to lens focal length.
⑥ Lighting	If the unit supports this feature, choose from: <ul style="list-style-type: none"> •  (FLASH POWER PRIORITY): Gain range by slightly reducing coverage. •  (STANDARD): Match coverage to picture angle. •  (EVEN COVERAGE PRIORITY): Slightly increase coverage for more even lighting.
⑦ LED light	Choose how the built-in LED light functions during still photography (compatible units only): as a catchlight ( / CATCHLIGHT), as an AF-assist illuminator (AF/AF ASSIST), or as both a catchlight and an AF-assist illuminator ( / AF ASSIST+CATCHLIGHT). Choose OFF to disable the LED during photography.
⑦ Number of flashes*	Choose the number of times the flash fires each time the shutter is released in MULTI mode.
⑧ Frequency*	Choose the frequency at which the flash fires in MULTI mode.

* Full value may not be applied if limits of flash control system are exceeded.

COMMANDER(OPTICAL)

The options will be displayed if the unit is currently functioning as a commander for Fujifilm optical wireless remote flash control.

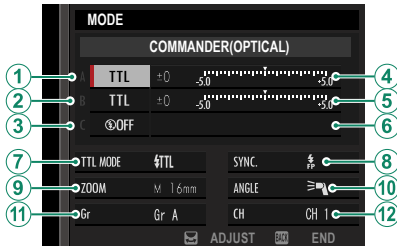





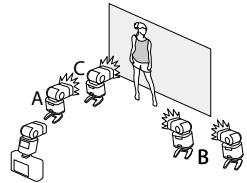





Fujifilm optical wireless remote flash control offers a choice of four channels (Channels 1 through 4) for the exchange of optical signals between the commander and remote flash units. Separate channels can be used for different flash systems or to prevent interference when multiple systems are operating in close proximity.

The flash units can also be placed in up to three groups (A, B, and C) and flash mode and flash level adjusted separately for each group.



Setting	Description
① Flash control mode (group A)	<p>Choose flash control modes for groups A, B, and C. TTL% is available for groups A and B only.</p> <ul style="list-style-type: none"> • TTL: The units in the group fire in TTL mode. Flash compensation can be adjusted separately for each group. • TTL%: If TTL% is selected for either group A or B, you can specify the output of the selected group as a percentage of the other and adjust overall flash compensation for both groups.
② Flash control mode (group B)	<ul style="list-style-type: none"> • M: In mode M, the units in the group fire at the selected output (expressed as a fraction of full power) regardless of subject brightness or camera settings.
③ Flash control mode (group C)	<ul style="list-style-type: none"> • MULTI: Choosing MULTI for any group sets all the units in all groups to repeating flash mode. All units will fire multiple times with each shot. • OFF (OFF): If OFF is selected, the units in the group will not fire.
④ Flash compensation/output (group A)	<p>Adjust flash level for the selected group according to option selected for flash control mode. Note that the full value may not be applied if the limits of the flash control system are exceeded.</p>
⑤ Flash compensation/output (group B)	<ul style="list-style-type: none"> • TTL: Adjust flash compensation.
⑥ Flash compensation/output (group C)	<ul style="list-style-type: none"> • M/MULTI: Adjust flash output. • TTL%: Choose the balance between groups A and B and adjust overall flash compensation.

Setting	Description
<p>⑦ Flash mode (TTL)</p>	<p>Choose a flash mode for TTL flash control. The options available vary with the shooting mode (P, S, A, or M) selected.</p> <ul style="list-style-type: none"> •  (FLASH AUTO): The flash fires only as required; flash level is adjusted according to subject brightness. A  icon displayed when the shutter button is pressed halfway indicates that the flash will fire when the photo is taken. •  (STANDARD): The flash fires with every shot if possible; flash level is adjusted according to subject brightness. The flash will not fire if not fully charged when the shutter is released. •  (SLOW SYNC.): Combine the flash with slow shutter speeds when photographing portrait subjects against a backdrop of night scenery. The flash will not fire if not fully charged when the shutter is released.
<p>⑧ Sync</p>	<p>Control flash timing.</p> <ul style="list-style-type: none"> •  (1ST CURTAIN): The flash fires immediately after the shutter opens (generally the best choice). •  (2ND CURTAIN): The flash fires immediately before the shutter closes. •  (AUTO FP(HSS)): High-speed sync (compatible units only). The camera automatically engages front-curtain high-speed sync at shutter speeds faster than the flash sync speed. Equivalent to 1ST CURTAIN when MULTI is selected for flash control mode.
<p>⑨ Zoom</p>	<p>The angle of illumination (flash coverage) for units that support flash zoom. Some units allow the adjustment to be made from the camera. If AUTO is selected, zoom will automatically be adjusted to match coverage to lens focal length.</p>
<p>⑩ Lighting</p>	<p>If the unit supports this feature, choose from:</p> <ul style="list-style-type: none"> •  (FLASH POWER PRIORITY): Gain range by slightly reducing coverage. •  (STANDARD): Match coverage to picture angle. •  (EVEN COVERAGE PRIORITY): Slightly increase coverage for more even lighting.

Setting	Description
⑪ Commander	<p>Choose the group for units functioning as a commander for Fujifilm optical wireless remote flash control in TTL, TTL%, or M mode. This option is available only with clip-on flash units that support Fujifilm optical wireless remote flash control.</p> <ul style="list-style-type: none"> • Gr A: Assign the commander to group A. • Gr B: Assign the commander to group B. • Gr C: Assign the commander to group C. • OFF: Output from the commander is held to a level that does not affect the final picture.
⑪ Number of flashes	<p>Choose the number of times the flash fires each time the shutter is released in MULTI mode.</p>
⑫ Channel	<p>Choose the channel used by the commander for communication with the remote flash units. Separate channels can be used for different flash systems or to prevent interference when multiple systems are operating in close proximity.</p>
⑫ Frequency	<p>Choose the frequency at which the flash fires in MULTI mode.</p>

Vertical Battery Grips

The VG-XH vertical battery grip can be used to supplement the camera battery or when holding the camera rotated to take pictures in portrait ("tall") orientation.

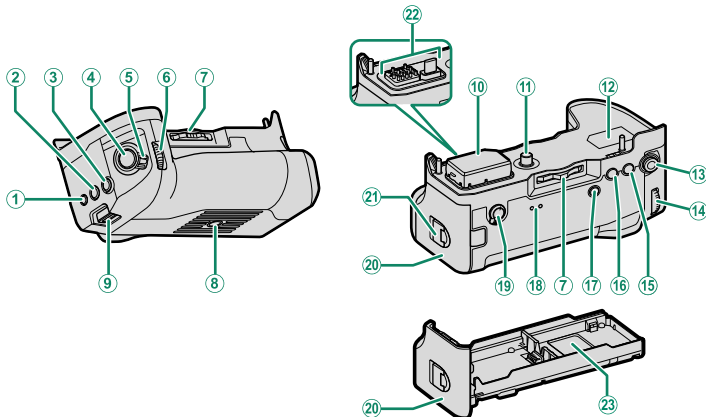

- ① **Fn1** button
- ② **WB** button
- ③ **ISO** button
- ④ Shutter button
- ⑤ Control lock
- ⑥ Front command dial
- ⑦ Lock screw knob
- ⑧ Tripod socket
- ⑨ Eyelet for camera strap

- ⑩ Connector cover
- ⑪ Lock screw
- ⑫ Serial number plate
- ⑬ Focus stick (focus lever)
- ⑭ Rear command dial
- ⑮ **AFON** button
- ⑯ **AEL** (exposure lock) button
- ⑰ **Q** (quick menu) button
- ⑱ Indicator lamps
- ⑲ Performance selector
- ⑳ Battery tray
- ㉑ Battery-chamber cover latch
- ㉒ Connector
- ㉓ Compartment for connector cover supplied with camera



All controls perform the same function as the matching controls on the camera.

Attaching the Vertical Battery Grip

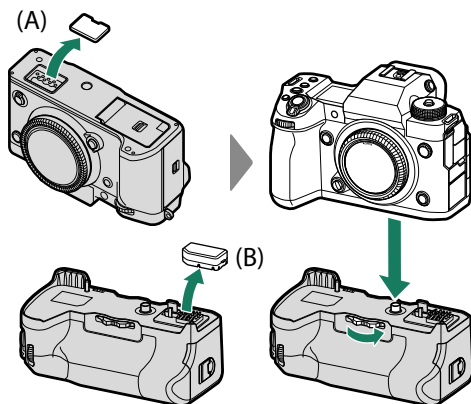

- Check that the camera is off before attaching or removing the vertical battery grip.
- The camera file transmitter/vertical battery grip connector cover (A) can be stored in the grip connector cover compartment. Keep the grip contact cap (B) in a safe place when not in use.

- Fully tighten the lock screw knob after attaching the grip.
- Do not touch the contacts.
- After removing the grip, replace the file transmitter/vertical battery grip connector cover (A) and contact cap (B).
- The grip is not waterproof, and caution is required to prevent the entry of dirt, dust, water, noxious gases, salt, and other foreign matter. Do not place the grip on wet surfaces. Before use, be sure that the battery tray and battery-chamber cover are fully closed.

Inserting and Removing Batteries

Insert the batteries as shown.

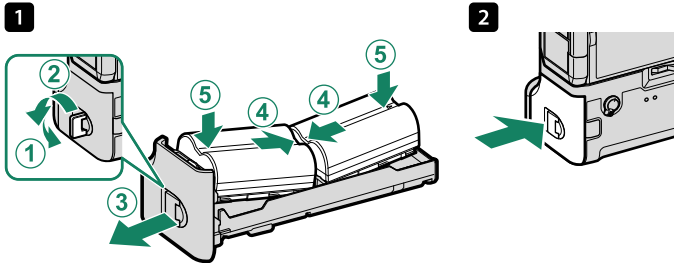

The batteries can be removed as shown.

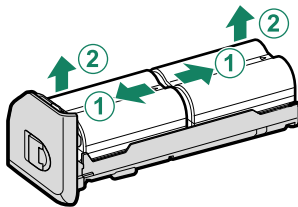

- Be sure the camera is off before exchanging batteries.
- Use only NP-W235 batteries.

Battery Level

When a vertical battery grip is connected, the camera battery level display shows the camera battery level and the level of the batteries inserted in the VG-XH.

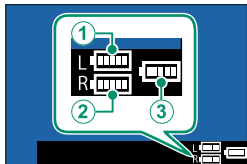

- The display shows the level of inserted batteries only.
- When a full complement of batteries are inserted in the camera and the VG-XH, the batteries will be used in the following order:
 - ① The left grip battery (**L**)
 - ② The right grip battery (**R**)
 - ③ The camera battery

Charging the Batteries

The batteries in the vertical battery grip will charge when the grip is attached to a camera that is connected to an AC-5VJ AC adapter via a USB cable.

The indicator lamps will light green while the battery charges; the lamp on the left shows the status of the left battery, the lamp on the right the status of the right battery.

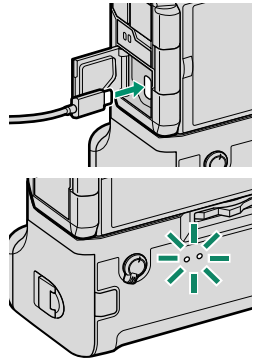

Indicator lamp	Battery status
On	Battery charging
Off	Charging complete
Blinks	Battery fault

- All three batteries charge simultaneously; charging takes about 330 minutes.
- Using a device that supplies power with an outputs of 45 W or above reduces charging times to as little as 180 minutes.
- The batteries will not charge while the camera is on.
- For more information, see “Charging the Battery” (📖 46) and “The Battery and Power Supply” (📖 350).

File Transmitters

Attach an optional FT-XH file transmitter to connect to wireless LAN or Ethernet networks for file upload or tethered photography. The FT-XH can also be used in combination with a battery inserted in the camera for greater battery capacity.

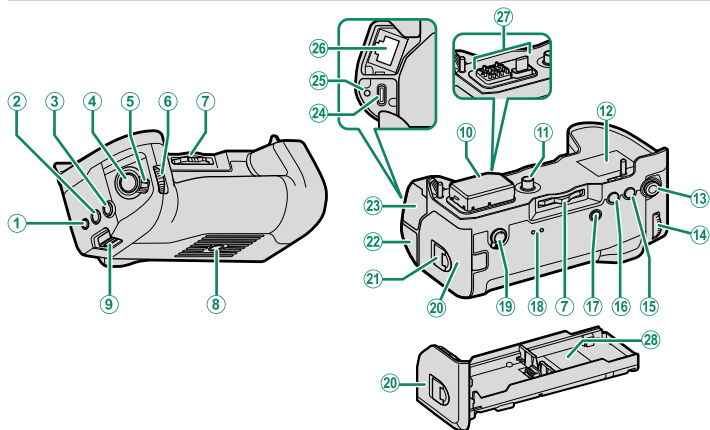

- ① **Fn1** button
- ② **WB** button
- ③ **ISO** button
- ④ Shutter button
- ⑤ Control lock
- ⑥ Front command dial
- ⑦ Lock screw knob
- ⑧ Tripod socket
- ⑨ Eyelet for camera strap
- ⑩ Connector cover
- ⑪ Lock screw
- ⑫ Serial number plate
- ⑬ Focus stick (focus lever)
- ⑭ Rear command dial
- ⑮ **AFON** button
- ⑯ **AEL** (exposure lock) button
- ⑰ **Q** (quick menu) button
- ⑱ Indicator lamps
- ⑲ Performance selector
- ⑳ Battery tray
- ㉑ Battery-chamber cover latch
- ㉒ USB connector cover
- ㉓ LAN connector cover
- ㉔ USB connector (Type-C)
- ㉕ Hole to screw USB cable
- ㉖ LAN connector
- ㉗ Connector
- ㉘ Compartment for connector cover supplied with camera

-  • The controls on the FT-XH perform the same functions as the matching controls on the camera.
- The USB (Type-C) connector is for smartphone tethering only. Use the camera USB connector when uploading pictures to a computer or smartphone, performing tethered photography via USB, or charging batteries.
- For information for accessing network/USB features while the file transmitter is connected, visit:
https://fujifilm-dsc.com/en/manual/x-h2_connection/

Attaching the File Transmitter

The procedure is the same as for vertical battery grips (📖 330).

Inserting and Removing Batteries

The procedure is the same as for vertical battery grips (📖 331).

-  Access to the network/USB features is only available when a battery is inserted in the camera and at least one battery is inserted in the transmitter.

Charging the Batteries

The procedure is the same as for vertical battery grips (📖 333).

Cooling Fans

Cooling fans help keep the camera cool, allowing longer periods of non-stop movie recording.

Attaching a Cooling Fan

Open the monitor and attach an FAN-001 cooling fan.

! Turn the camera off before attaching or removing the fan.

- 1 Open the monitor.

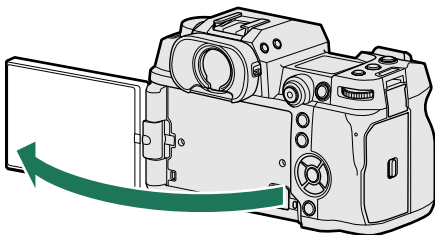

- 2 Remove the camera cooling fan connector cover and the fan connector cap.
After removing the cooling fan connector cover (A), attach it to the fan for safe-keeping. Keep the fan connector cap (B) in a safe place.

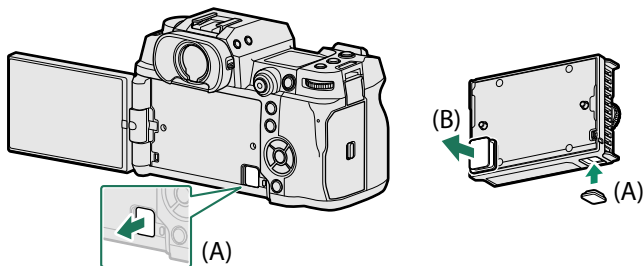

- 3 Place the fan on the camera, making sure the screws and connectors are correctly aligned.

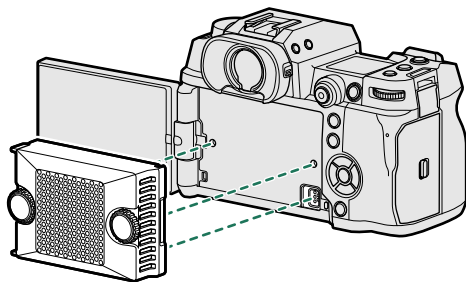



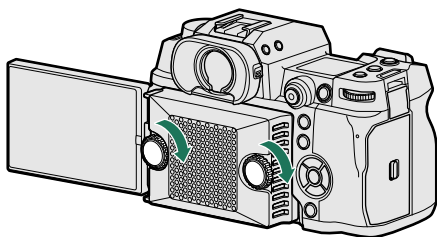

- 4 Tighten the screws.



 The cooling fan may fall off if the screws are not sufficiently tightened.

Using the Fan

Fan speed can be adjusted using the  **SHOOTING SETTING** >  **COOLING FAN SETTING** and  **MOVIE SETTING** >  **COOLING FAN SETTING** options in the photo and movie menus, respectively. Select **OFF** to turn the fan off.

 At some speeds, the noise of the fan may be audible in movies recorded with the camera.

12

Technical Notes

Accessories from Fujifilm

The following optional accessories are available from Fujifilm. For the latest information on the accessories available in your region, check with your local Fujifilm representative or visit <https://fujifilm-x.com/support/compatibility/cameras/>.

Rechargeable Li-ion batteries

NP-W235: Additional high-capacity NP-W235 rechargeable batteries can be purchased as required.

Dual battery chargers

BC-W235: The BC-W235 can charge up to two NP-W235 batteries at a time. At +25 °C/+77 °F, the batteries will charge in about 200 minutes. Using a device that supplies power with an outputs of 30 W or above reduces charging times to as little as 150 minutes.

Eye cups

EC-XH W/EC-XT L/EC-XT M/EC-XT S/EC-GFX: Attach viewfinder eyecups to prevent light leaking into the viewfinder window.

Remote releases

RR-100: Use to reduce camera shake or keep the shutter open during a time exposure (ø2.5 mm).

Stereo microphones

MIC-ST1: An external microphone for movie recording.

FUJINON lenses

XF-/XC-series lenses: Interchangeable lenses for use exclusively with the FUJIFILM X-mount.

FUJINON MKX-series lenses: Cinema lenses for the FUJIFILM X-mount.

Macro extension tubes

MCEX-11/16: Attach between the camera and the lens to shoot at high reproduction ratios.

Teleconverters

XF1.4X TC WR: Increases the focal length of the compatible lenses by about 1.4x.

XF2X TC WR: Increases the focal length of the compatible lenses by about 2.0x.

Mount adapters

FUJIFILM M MOUNT ADAPTER: Allows the camera to be used with a wide selection of M-mount lenses.

Body caps

BCP-001: Cover the camera lens mount when no lens is attached.

Shoe-mounted flash units

EF-X500: In addition to manual and TTL flash control, this clip-on flash unit has a Guide Number of 50/164 (ISO 100, m/ft.) and supports FP (high-speed sync), allowing it to be used at shutter speeds that exceed the flash sync speed. Featuring support for the optional EF-BP1 battery pack and Fujifilm optical wireless flash control, it can be used as a commander or remote flash unit for remote wireless flash photography.

EF-BP1: A battery pack for EF-X500 flash units. Takes up to 8 AA batteries.

EF-60: In addition to manual and TTL flash control, this clip-on flash unit has a Guide Number of 60/197 (ISO 100, m/ft.) and supports FP (high-speed sync), allowing it to be used at shutter speeds that exceed the flash sync speed. It can also be used as remote flash under the control of an optional EF-W1 wireless commander.

EF-W1: With support for the NAS* wireless communication standard developed by Nissin Japan, this wireless flash commander can be used with optional EF-60 clip-on flash units and other NAS-compliant units.

* NAS is a registered trademark of Nissin Japan Ltd.

EF-X8: This compact, clip-on flash unit draws power from the camera has a Guide Number of approximately 8/26 (ISO 100, m/ft.) and can cover the angle of view of a 16 mm lens (equivalent to 24 mm in 35 mm format).

EF-42: This clip-on flash unit has a Guide Number of 42/137 (ISO 100, m/ft.) and supports manual and TTL flash control.

EF-X20: This clip-on flash unit has a Guide Number of 20/65 (ISO 100, m/ft.) and supports manual and TTL flash control.

EF-20: This clip-on flash unit has a Guide Number of 20/65 (ISO 100, m/ft.) and supports TTL flash control (manual flash control is not supported).

Vertical battery grips

VG-XH: See “Vertical battery grips” (📖 329).

File transmitters

FT-XH: See "File Transmitters" (📖 334).

Cooling fans

FAN-001: See "Cooling Fans" (📖 336).

Grip belts

GB-001: Improves grip. Combine with a hand grip for more secure handling.

Cover kits

CVR-XH: A set of covers for the X-H2. Contains a sync terminal cap, a hot-shoe cover, and a memory card slot cover, as well as two file transmitter/vertical battery grip connector covers.

instax SHARE printers

SP-1/SP-2/SP-3: Connect via wireless LAN to print pictures on instax film.

Software for Use with Your Camera

The camera can be used with the following software. For the latest information on software available from Fujifilm, visit <https://fujifilm-x.com/support/compatibility/cameras/>.

Smartphone Apps

Establish a wireless connection between your camera and a smartphone or tablet.

<https://app.fujifilm-dsc.com/>

RAW FILE CONVERTER EX powered by SILKYPIX

RAW FILE CONVERTER EX powered by SILKYPIX is RAW conversion software from Ichikawa Soft Laboratory Co., Ltd. View RAW pictures on your computer and convert them into other formats. RAW FILE CONVERTER EX powered by SILKYPIX is available free of charge from the Fujifilm website.

<https://fujifilm-x.com/support/download/software/raw-file-converter-ex-powered-by-silkypix/>



- "RAW FILE CONVERTER EX powered by SILKYPIX" is supplied by Ichikawa Soft Laboratory Co., Ltd.
- For information on when support will be available, visit:
<https://fujifilm-x.com/support/compatibility/software/raw-file-converter-ex-powered-by-silkypix/>

Capture One Express for Fujifilm

View RAW pictures on your computer and convert them into other formats. Capture One Express for Fujifilm is available free of charge from Capture One A/S.

<https://www.captureone.com/products-plans/capture-one-express/fujifilm>



Visit the website above for information on when support will be available.

Capture One for Fujifilm

Capture One for Fujifilm workflow software from Capture One A/S supports tethered shooting and the conversion of RAW pictures into other formats.

<https://www.captureone.com/explore-features/fujifilm>



Visit the website above for information on when support will be available.

FUJIFILM Tether Shooting Plug-in (Exclusively for Lightroom)

A plug-in for Adobe Lightroom Classic.

- *FUJIFILM Tether Shooting Plug-in PRO/FUJIFILM Tether Shooting Plug-in*
<https://fujifilm-x.com/products/software/adobe-photoshop-lightroom-tether-plugin/>

FUJIFILM X Acquire

This computer application lets you connect to the camera via USB or Wi-Fi and automatically download photos to a specified folder as they are taken, or backup and restore the camera via USB.

<https://fujifilm-x.com/products/software/x-acquire/>

FUJIFILM X RAW STUDIO

When the camera is connected to a computer via USB, FUJIFILM X RAW STUDIO can use the camera's unique image processing engine to rapidly convert RAW files to create high-quality images in other formats.

<https://fujifilm-x.com/products/software/x-raw-studio/>

FUJIFILM Pixel Shift Combiner

Computer software for combining pictures taken using pixel-shift multi-shot or reducing false colors (📖 125).

<https://fujifilm-x.com/products/software/pixel-shift-combiner/>

For Your Safety

IMPORTANT SAFETY INSTRUCTIONS

- **Read Instructions:** All the safety and operating instructions should be read before the appliance is operated.
- **Retain Instructions:** The safety and operating instructions should be retained for future reference.
- **Heed Warnings:** All warnings on the appliance and in the operating instructions should be adhered to.
- **Follow Instructions:** All operating and use instructions should be followed.

Installation

Power Sources: This video product should be operated only from the type of power source indicated on the marking label. If you are not sure of the type of power supply to your home, consult your appliance dealer or local power company. For video products intended to operate from battery power, or other sources, refer to the operating instructions.

Grounding or Polarization: This video product is equipped with a polarized alternating-current line plug (a plug having one blade wider than the other). This plug will fit into the power outlet only one way. This is a safety feature. If you are unable to insert the plug fully into the outlet, try reversing the plug. If the plug should still fail to fit, contact your electrician to replace your obsolete outlet. Do not defeat the safety purpose of the polarized plug.

Alternate Warnings: This video product is equipped with a three-wire grounding-type plug, a plug having a third (grounding) pin. This plug will only fit into a grounding-type power outlet. This is a safety feature. If you are unable to insert the plug into the outlet, contact your electrician to replace your obsolete outlet. Do not defeat the safety purpose of the grounding type plug.

Overloading: Do not overload wall outlets and extension cords as this can result in a risk of fire or electric shock.

Ventilation: Slots and openings in the cabinet are provided for ventilation, to ensure reliable operation of the video product and to protect it from overheating, and these openings must not be blocked or covered. The openings should never be blocked by placing the video product on a bed, sofa, rug, or other similar surface.

This video product should not be placed in a built-in installation such as a bookcase or rack unless proper ventilation is provided or the manufacturer's instructions have been adhered to. This video product should never be placed near or over a radiator or heat register.

Attachments: Do not use attachments not recommended by the video product manufacturer as they may cause hazards.

Water and Moisture: Do not use this video product near water—for example, near a bath tub, wash bowl, kitchen sink, or laundry tub, in a wet basement, or near a swimming pool, and the like.

Power-Cord Protection: Power-supply cords should be routed so that they are not likely to be walked on or pinched by items placed upon or against them, paying particular attention to cords at plugs, convenience receptacles, and the point where they exit from the appliance.

Accessories: Do not place this video product on an unstable cart, stand, tripod, bracket, or table. The video product may fall, causing serious injury to a child or adult, and serious damage to the appliance. Use only with a cart, stand, tripod, bracket, or table recommended by the manufacturer, or sold with the video product. Any mounting of the appliance should follow the manufacturer's instructions, and should use a mounting accessory recommended by the manufacturer.

An appliance and cart combination should be moved with care. Quick stops, excessive force, and uneven surfaces may cause the appliance and cart combination to overturn.



Antennas

Outdoor Antenna Grounding: If an outside antenna or cable system is connected to the video product, be sure the antenna or cable system is grounded so as to provide some protection against voltage surges and built-up static charges. Section 810 of the National Electrical Code, ANSI/NFPA No. 70, provides information with respect to proper grounding of the mast and supporting structure, grounding of the lead-in wire to an antenna discharge unit, size of grounding conductors, location of antenna discharge unit, connection to grounding electrodes, and requirements for the grounding electrode.

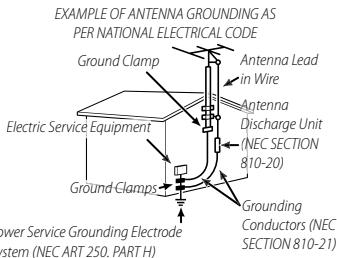

Power Lines: An outside antenna system should not be located in the vicinity of overhead power lines or other electric light or power circuits, or where it can fall into such power lines or circuits. When installing an outside antenna system, extreme care should be taken to keep from touching such power lines or circuits as contact with them might be fatal.

Use

Cleaning: Unplug this video product from the wall outlet before cleaning. Do not use liquid cleaners or aerosol cleaners. Use a damp cloth for cleaning.

Object and Liquid Entry: Never push objects of any kind into this video product through openings as they may touch dangerous voltage points or short out parts that could result in a fire or electric shock. Never spill liquid of any kind on the video product.

Lightning: For added protection for this video product receiver during a lightning storm, or when it is left unattended and unused for long periods of time, unplug it from the wall outlet and disconnect the antenna or cable system. This will prevent damage to the video product due to lightning and power-line surges.

Service

Servicing: Do not attempt to service this video product yourself as opening or removing covers may expose you to dangerous voltage or other hazards. Refer all servicing to qualified service personnel.

Damage Requiring Service: Unplug this video product from the wall outlet and refer servicing to qualified service personnel under the following conditions:

- When the power-supply cord or plug is damaged
- If liquid has been spilled, or objects have fallen into the video product.
- If the video product has been exposed to rain or water.
- If the video product has been dropped or the cabinet has been damaged.

If the video product does not operate normally follow the operating instructions. Adjust only those controls that are covered by the operating instructions as an improper adjustment of other controls may result in damage and will often require extensive work by a qualified technician to restore the video product to its normal operation.

When the video product exhibits a distinct change in performance — this indicates a need for service.

Replacement Parts: When replacement parts are required, be sure the service technician has used replacement parts specified by the manufacturer or have the same characteristics as the original part. Unauthorized substitutions may result in fire, electric shock or other hazards.

Safety Check: Upon completion of any service or repairs to this video product, ask the service technician to perform safety checks to determine that the video product is in proper operating condition.



Be sure to read these notes before use

Safety Notes



- Make sure that you use your camera correctly. Read these safety notes and your *Basic Manual* carefully before use.
- After reading these safety notes, store them in a safe place.

About the Icons



The icons shown below are used in this document to indicate the severity of the injury or damage that can result if the information indicated by the icon is ignored and the product is used incorrectly as a result.

	WARNING	This icon indicates that death or serious injury can result if the information is ignored.
	CAUTION	This icon indicates that personal injury or material damage can result if the information is ignored.

The icons shown below are used to indicate the nature of the instructions which are to be observed.

	Triangular icons tell you that this information requires attention ("Important").
	Circular icons with a diagonal bar tell you that the action indicated is prohibited ("Prohibited").
	Filled circles with an exclamation mark indicate an action that must be performed ("Required").











The symbols on the product (including the accessories) represent the following:











	AC
	DC
	Class II equipment (The construction of the product is double-insulated.)















WARNING

If a problem arises, turn the camera off, remove the battery, disconnect the USB cable, and unplug the AC power adapter. Continued use of the camera when it is emitting smoke, is emitting any unusual odor, or is in any other abnormal state can cause a fire or electric shock. Contact your Fujifilm dealer.

Do not allow water or foreign objects to enter the camera or connecting cables. Do not use the camera or connecting cables following ingress of fresh or salt water, milk, beverages, detergents, or other liquids. **Should liquid find its way into the camera or connecting cables, turn the camera off, remove the battery, disconnect the USB cable, and disconnect and unplug the AC adapter.** Continued use of the camera can cause a fire or electric shock. Contact your Fujifilm dealer.

 WARNING	
	Do not use the camera in the bathroom or shower. This can cause a fire or electric shock.
	Never attempt to change or take apart the camera (never open the case). Failure to observe this precaution can cause fire or electric shock.
	Should the case break open as the result of a fall or other accident, do not touch the exposed parts. Failure to observe this precaution could result in electric shock or in injury from touching the damaged parts. Remove the battery immediately, taking care to avoid injury or electric shock, and take the product to the point of purchase for consultation.
	Do not change, heat or unduly twist or pull the connection cord and do not place heavy objects on the connection cord. These actions could damage the cord and cause a fire or electric shock. If the cord is damaged, contact your Fujifilm dealer. Do not use cables with bent connectors.
	Do not place the camera on an unstable surface. This can cause the camera to fall or tip over and cause injury.
	Never attempt to take pictures while in motion. Do not use the camera while walking or driving. This can result in you falling down or being involved in a traffic accident.
	Do not touch any metal parts of the camera during a thunderstorm. This can cause an electric shock due to induced current from the lightning discharge.
	Do not use the battery except as specified. Load the battery as shown by the indicator.
	Do not disassemble, modify, or heat batteries. Do not drop, strike, or throw batteries or otherwise subject them to strong impacts. Do not use batteries that show signs of leaking, deformation, discoloration, or other abnormalities. Use only designated chargers to recharge rechargeable batteries and do not attempt to recharge non-rechargeable Li-ion or alkaline batteries. Do not short batteries or store them with metallic objects. Failure to observe these precautions could result in the batteries overheating, igniting, rupturing, or leaking, causing fire, burns, or other injury.
	Use only batteries or AC power adapters specified for use with this camera. Do not use voltages other than the power supply voltage shown. The use of other power sources can cause a fire.

 WARNING	
	If the battery leaks and fluid gets in contact with your eyes, skin or clothing, flush the affected area with clean water and seek medical attention or call an emergency number right away.
	Do not use the charger to charge batteries other than those specified here. The supplied charger is for use only with batteries of the type supplied with the camera. Using the charger to charge conventional batteries or other types of rechargeable batteries can cause the battery to leak, overheat or burst.
	Using a flash too close to a person's eyes may cause visual impairment. Take particular care when photographing infants and young children.
	Do not remain in prolonged contact with hot surfaces. Do not leave one part of the body in contact with the product for prolonged periods while the product is on. Failure to observe this precaution could result in low-temperature burns, particularly during prolonged use, at high ambient temperatures, when HIGH is selected for AUTO POWER OFF TEMP. , or with users who suffer from poor circulation or reduced sensation, in which case use of a tripod or similar precautions are recommended.
	Do not use in the presence of flammable objects, explosive gases, or dust.
	When carrying the battery, install it in a digital camera or keep it in the hard case. When storing the battery, keep it in the hard case. When discarding, cover the battery terminals with insulation tape. Contact with other metallic objects or batteries could cause the battery to ignite or burst.
	Keep memory cards, hot shoes, and other small parts out of the reach of small children. Children may swallow small parts; keep out of reach of children. Should a child swallow a small part, seek medical attention or call emergency.
	Keep out of reach of small children. Among the elements that could cause injury are the strap, which could become entangled about a child's neck, causing strangulation, and the flash, which could cause visual impairment.
	Follow the directions of airline and hospital personnel. This product generates radio-frequency emissions that could interfere with navigational or medical equipment.

 CAUTION	
	<i>Do not use this camera in locations affected by oil fumes, steam, humidity or dust.</i> This can cause a fire or electric shock.
	<i>Do not leave this camera in places subject to extremely high temperatures.</i> Do not leave the camera in locations such as a sealed vehicle or in direct sunlight. This can cause a fire.
	<i>Do not place heavy objects on the camera.</i> This can cause the heavy object to tip over or fall and cause injury.
	<i>Do not move the camera while the AC power adapter is still connected.</i> Do not pull on the connection cord to disconnect the AC power adapter. This can damage the power cord or cables and cause a fire or electric shock.
	<i>Do not cover or wrap the camera or the AC power adapter in a cloth or blanket.</i> This can cause heat to build up and distort the casing or cause a fire.
	<i>Do not use the plug if it is damaged or if it does not fit securely into the outlet.</i> Failure to observe this precaution could result in fire or electric shock.
	<i>When you are cleaning the camera or you do not plan to use the camera for an extended period, remove the battery and disconnect and unplug the AC power adapter.</i> Failure to do so can cause a fire or electric shock.
	<i>When charging ends, unplug the charger from the power socket.</i> Leaving the charger plugged into the power socket can cause a fire.
	<i>When a memory card is removed, the card could come out of the slot too quickly. Use your finger to hold it and gently release the card.</i> Injury could result to those struck by the ejected card.
	<i>Do not handle the memory card immediately after shooting.</i> The memory card may be hot, resulting in burns. Wait for the card to cool before removing it from the camera.
	<i>Request regular internal testing and cleaning for your camera.</i> Build-up of dust in your camera can cause a fire or electric shock. Contact your Fujifilm dealer to request internal cleaning every two years. Please note that this service is not free of charge.
	<i>Dispose of the product in accord with location regulations.</i>
	<i>Danger of explosion if battery is incorrectly replaced. Replace only with the same or equivalent type.</i>
	<i>Batteries (battery pack or batteries installed) shall not be exposed to excessive heat such as sunshine, fire or the like.</i>

The Battery and Power Supply

Note: Check the type of battery used in your camera and read the appropriate sections.

⚠ WARNING: Battery shall not be exposed to excessive heat such as sunshine, fire or the like.

The following describes the proper use of batteries and how to prolong their life. Incorrect use can shorten battery life or cause leakage, overheating, fire, or explosion.

Li-ion Batteries

Read this section if your camera uses a rechargeable Li-ion battery.

The battery is not charged at shipment. Charge the battery before use. Keep the battery in its case when not in use.

■ Notes on the Battery

The battery gradually loses its charge when not in use. Charge the battery one or two days before use.

Battery life can be extended by turning the camera off when not in use.

Battery capacity decreases at low temperatures; a depleted battery may not function when cold. Keep a fully charged spare battery in a warm place and exchange as necessary, or keep the battery in your pocket or other warm place and insert it in the camera only when shooting. Do not place the battery in direct contact with hand warmers or other heating devices.

■ Charging the Battery

The battery can be charged using the camera and supplied AC adapter or an optional BC-W235 dual battery charger. Charging times will increase at ambient temperatures below +10°C (+50°F) or above +35°C (+95°F). Do not attempt to charge the battery at temperatures above +40°C (+104°F); at temperatures below +5°C (+41°F), the battery will not charge.

Do not attempt to recharge a fully charged battery. The battery does not however need to be fully discharged before charging.

The battery may be warm to the touch immediately after charging or use. This is normal.

■ Battery Life

A noticeable decrease in the length of time the battery will hold a charge indicates that it has reached the end of its service life and should be replaced.

If the battery is left for long periods without charging, you may find that its quality degrades or that it no longer holds a charge. Charge the battery regularly.

■ Storage

If the camera will not be used for an extended period, store it at room temperature with the battery charged to approximately one half to ¾ capacity.

If the camera will not be used for an extended period, remove the battery and store it in a dry place with an ambient temperature of from +15°C to +25°C (+59°F to +77°F). Do not store in locations exposed to extremes of temperature.

■ Cautions: Handling the Battery

- Do not transport or store with metal objects such as necklaces or hairpins.
- Do not expose to flame or heat.
- Do not disassemble or modify.
- Do not expose to low atmospheric pressures.
- Use with designated chargers only.
- Dispose of used batteries promptly.
- Do not drop or subject to strong physical shocks.
- Do not expose to water.
- Keep the terminals clean.
- The battery and camera body may become warm to the touch after extended use. This is normal.

■ Caution: Disposal

Dispose of used batteries in accord with local regulations. Attention should be drawn to the environmental aspects of battery disposal. Use the apparatus under moderate climate. Do not mechanically crush or split batteries.

AC Power Adapters

- The AC power adapter is for indoor use only.
- Be sure the cable is securely connected to the camera.
- Turn the camera off before disconnecting the adapter. Disconnect the adapter by the plug, not the cable.
- Do not disassemble.
- Do not expose to high heat and humidity.
- Do not subject to strong physical shocks.
- The adapter may hum or become hot to the touch during use. This is normal.
- If the adapter causes radio interference, reorient or relocate the receiving antenna.

Using the Camera

- Do not aim the camera at extremely bright light sources, including artificial light sources or natural light sources such as the sun in a cloudless sky. Failure to observe this precaution could damage the camera image sensor.
- Strong sunlight focused through the viewfinder may damage the panel of electronic viewfinder (EVF). Do not aim the electronic viewfinder at the sun.

Take Test Shots

Before taking photographs on important occasions (such as at weddings or before taking the camera on a trip), take a test shot and view the results to ensure that the camera is functioning normally. FUJIFILM Corporation cannot accept liability for damages or lost profits incurred as a result of product malfunction.

Notes on Copyright

Unless intended solely for personal use, images recorded using your digital camera system cannot be used in ways that infringe copyright laws without the consent of the owner. Note that some restrictions apply to the photographing of stage performances, entertainments, and exhibits, even when intended purely for personal use. Users are also asked to note that the transfer of memory cards containing images or data protected under copyright laws is only permissible within the restrictions imposed by those copyright laws.

Handling

To ensure that images are recorded correctly, do not subject the camera to impact or physical shocks while images are being recorded.

Liquid Crystal

In the event that the display is damaged, care should be taken to avoid contact with liquid crystal. Take the urgent action indicated should any of the following situations arise:

- If liquid crystal comes in contact with your skin**, clean the area with a cloth and then wash thoroughly with soap and running water.
- If liquid crystal enters your eyes**, flush the affected eye with clean water for at least 15 minutes and then seek medical assistance.
- If liquid crystal is swallowed**, rinse your mouth thoroughly with water. Drink large quantities of water and induce vomiting, then seek medical assistance.

Although the display is manufactured using extremely high-precision technology, it may contain pixels that are always lit or that do not light. This is not a malfunction, and images recorded with the product are unaffected.

Trademark Information

Digital Split Image is a trademark or registered trademark of FUJIFILM Corporation. Digital Micro Prism is a trademark or registered trademark of FUJIFILM Corporation. The typefaces included herein are solely developed by DynaComware Taiwan Inc. Apple, iPhone, iPad, Mac, Mac OS X, OS X, macOS, Lightning and Apple ProRes are registered trademarks of Apple Inc. in the U.S.A. and other countries. Windows is a registered trademark of Microsoft Corporation in the U.S.A. and other countries. Android is a trademark or registered trademark of Google LLC. Adobe, the Adobe logo, Photoshop, and Lightroom are trademarks or registered trademarks of Adobe Systems Incorporated in the U.S.A. and other countries. Wi-Fi®, the Wi-Fi CERTIFIED logo, and Wi-Fi Protected Setup® are registered trademarks of the Wi-Fi Alliance®. The Bluetooth® word mark and logos are registered trademarks owned by the Bluetooth SIG, Inc., and any use of such marks by Fujifilm is under license. The SDHC and SDXC logos are trademarks of SD-3C, LLC. C.Fexpress is a trademark of the CFA (CompactFlash Association). The HDMI logo is a trademark or registered trademark of HDMI Licensing LLC. All other trade names mentioned in this manual are the trademarks or registered trademarks of their respective owners.

Electrical Interference

This camera may interfere with hospital or aviation equipment. Consult with hospital or airline staff before using the camera in a hospital or on an aircraft.

Color Television Systems

NTSC (National Television System Committee) is a color television telecasting specification adopted mainly in the U.S.A., Canada, and Japan. PAL (Phase Alternation by Line) is a color television system adopted mainly in European countries and China.

Exif Print (Exif Version 2.32)

Exif Print is a newly revised digital camera file format in which information stored with photographs is used for optimal color reproduction during printing.

IMPORTANT NOTICE: Read Before Using the Software

Direct or indirect export, in whole or in part, of licensed software without the permission of the applicable governing bodies is prohibited.

Lenses and Other Accessories

- Use a screw 4.5 mm or shorter when attaching a tripod.
- Fujifilm will not be held liable for performance issues or damage caused by the use of third-party accessories.

NOTICES

To prevent fire or shock hazard, do not expose the unit to rain or moisture.

Please read the "Safety Notes" and make sure you understand them before using the camera.

Perchlorate Material—special handling may apply. See:

<http://www.dtsc.ca.gov/hazardouswaste/perchlorate>

For Customers in the U.S.A.

Tested To Comply With FCC Standards FOR HOME OR OFFICE USE



Contains IC : 10293A-WMBACBM25

Contains FCC ID : COF-WMBACBM25

FCC Statement: This device complies with Part 15 of the FCC Rules. Operation is subject to the following two conditions:

- (1) This device may not cause harmful interference, and
- (2) this device must accept any interference received, including interference that may cause undesired operation.

CAUTION: This equipment has been tested and found to comply with the limits for a Class B digital device, pursuant to Part 15 of the FCC Rules. These limits are designed to provide reasonable protection against harmful interference in a residential installation. This equipment generates, uses, and can radiate radio frequency energy and, if not installed and used in accordance with the instructions, may cause harmful interference to radio communications. However, there is no guarantee that interference will not occur in a particular installation. If this equipment does cause harmful interference to radio or television reception, which can be determined by turning the equipment off and on, the user is encouraged to try to correct the interference by one or more of the following measures:

- Reorient or relocate the receiving antenna.
- Increase the separation between the equipment and receiver.
- Connect the equipment into an outlet on a circuit different from that to which the receiver is connected.
- Consult the dealer or an experienced radio/TV technician for help.

FCC Caution: Any changes or modifications not expressly approved by the party responsible for compliance could void the user's authority to operate this equipment.

This transmitter must not be co-located or operating in conjunction with any other antenna or transmitter.

Radiation Exposure Statement: This device meets the government's requirements for exposure to radio waves. This device is designed and manufactured not to exceed the emission limits for exposure to radio frequency (RF) energy set by the Federal Communications Commission of the U.S. Government.

The exposure standard for wireless device employs a unit of measurement known as the Specific Absorption Rate, or SAR. The SAR limit set by the FCC is 1.6W/kg. Tests for SAR are conducted using standard operating positions accepted by the FCC with the device transmitting at its highest certified power level in all tested frequency bands.

Notes on the Grant: To comply with Part 15 of the FCC Rules, this product must be used with a Fujifilm-specified ferrite-core A/V cable, USB cable, and DC supply cord.



A lithium ion battery that is recyclable powers the product you have purchased. Please call 1-800-8-BATTERY for information on how to recycle this battery.



California Code of Regulations, Title 20, Division 2, Chapter 4, Article 4, Appliance Efficiency Regulations, Sections 1601 through 1609

For Customers in Canada**CAN ICES-003 (B)/NMB-003(B)**

CAUTION: This Class B digital apparatus complies with Canadian ICES-003.

Industry Canada statement: This device complies with Industry Canada's licence-exempt RSSs. Operation is subject to the following two conditions: (1) This device may not cause interference; and (2) This device must accept any interference, including interference that may cause undesired operation of the device.

This device and its antenna(s) must not be co-located or operating in conjunction with any other antenna or transmitter, except tested built-in radios. The County Code Selection feature is disabled for products marketed in the US/ Canada.

Radiation Exposure Statement: The available scientific evidence does not show that any health problems are associated with using low power wireless devices. There is no proof, however, that these low power wireless devices are absolutely safe. Low power Wireless devices emit low levels of radio frequency energy (RF) in the microwave range while being used. Whereas high levels of RF can produce health effects (by heating tissue), exposure of low-level RF that does not produce heating effects causes no known adverse health effects. Many studies of low-level RF exposures have not found any biological effects. Some studies have suggested that some biological effects might occur, but such findings have not been confirmed by additional research. X-H2 has been tested and found to comply with IC radiation exposure limits set forth for an uncontrolled environment and meets RSS-102 of the IC radio frequency (RF) Exposure rules.

Operation in the band 5150–5250 MHz is only for indoor use to reduce the potential for harmful interference to co-channel mobile satellite systems.

Disposal of Electrical and Electronic Equipment in Private Households

In the European Union, Norway, Iceland and Liechtenstein: This symbol on the product, or in the manual and in the warranty, and/or on its packaging indicates that this product shall not be treated as household waste. Instead it should be taken to an applicable collection point for the recycling of electrical and electronic equipment.



By ensuring this product is disposed of correctly, you will help prevent potential negative consequences to the environment and human health, which could otherwise be caused by inappropriate waste handling of this product.

This symbol on the batteries or accumulators indicates that those batteries shall not be treated as household waste.



If your equipment contains easy removable batteries or accumulators please dispose these separately according to your local requirements.

The recycling of materials will help to conserve natural resources. For more detailed information about recycling this product, please contact your local city office, your household waste disposal service or the shop where you purchased the product.

In Countries Outside the European Union, Norway, Iceland and Liechtenstein: If you wish to discard this product, including the batteries or accumulators, please contact your local authorities and ask for the correct way of disposal.

In Japan: This symbol on the batteries indicates that they are to be disposed of separately.

**Caring for the Camera**

To ensure continued enjoyment of the product, observe the following precautions.

Storage and Use

If the camera will not be used for an extended period, remove the battery and memory card. Do not store or use the camera in locations that are:

- exposed to rain, steam, or smoke
- very humid or extremely dusty
- exposed to direct sunlight or very high temperatures, such as in a closed vehicle on a sunny day
- extremely cold
- subject to strong vibration
- exposed to strong magnetic fields, such as near a broadcasting antenna, power line, radar emitter, motor, transformer, or magnet
- in contact with volatile chemicals such as pesticides
- next to rubber or vinyl products

Wireless Network and Bluetooth Devices: Cautions

This product complies with the following EU Directives:

- RoHS Directive 2011/65/EU
- RE Directive 2014/53/EU

Hereby, FUJIFILM Corporation declares that the radio equipment type FF210003 is in compliance with Directive 2014/53/EU.

The full text of the EU declaration of conformity is available at the following internet address:

https://dl.fujifilm-x.com/global/products/cameras/x-h2/pdf/x-h2_doc-myt.pdf

The full text of the UK declaration of conformity is available at the following internet address:

https://dl.fujifilm-x.com/en-gb/products/cameras/x-h2/pdf/x-h2_doc-myt_uk.pdf

This compliance is indicated by the following conformity marking placed on the product:



This marking is valid for non-Telecom products and EU harmonized Telecom products (e.g. Bluetooth®).

• **Maximum radio-frequency power (EIRP):**

- WLAN 2.4 GHz: 10.28 dBm
- WLAN 5 GHz: 12.29 dBm
- Bluetooth: 2.23 dBm

IMPORTANT: Read the following notices before using the camera's built-in wireless transmitter.

Ⓢ This product, which contains encryption function developed in the United States, is controlled by the United States Export Administration Regulations and may not be exported or re-exported to any country to which the United States embargoes goods.

- **Use only a wireless network or Bluetooth device.** Fujifilm does not accept liability for damages resulting from unauthorized use. Do not use in applications requiring a high degree of reliability, for example in medical devices or other systems that may directly or indirectly impact human life. When using the device in computer and other systems that demand a greater degree of reliability than offered by wireless network or Bluetooth devices, be sure to take all necessary precautions to ensure safety and prevent malfunction.
- **Use only in the country in which the device was purchased.** This device conforms to regulations governing wireless network and Bluetooth devices in the country in which it was purchased. Observe all location regulations when using the device. Fujifilm does not accept liability for problems arising from use in other jurisdictions.
- **Do not use the device in locations subject to magnetic fields, static electricity, or radio interference.** Do not use the transmitter in the vicinity of microwave ovens or in other locations subject to magnetic fields, static electricity, or radio interference that may prevent reception of wireless signals. Mutual interference may occur when the transmitter is used in the vicinity of other wireless devices operating in the 2.4 GHz band.
- **The wireless transmitter operates in the 2.4 GHz and 5 GHz bands using DSSS, OFDM and GFSK modulation.**
- **Security:** Wireless network and Bluetooth devices transmit data via radio and consequently their use requires greater attention to security than applies in the case of wired networks.
 - Do not connect to unknown networks or networks to which you do not have access rights, even if they are displayed on your device, as such access may be considered unauthorized. Connect only to networks to which you have access rights.
 - Be aware that wireless transmissions may be vulnerable to interception by third parties.
 - This device cannot be directly connected to telecommunications networks (including public wireless LANs) operated by providers or mobile, landline, Internet, or other telecommunications services.
- **The following may be punishable by law:**
 - Disassembly or modification of this device
 - Removal of device certification labels
- **This device operates on the same frequency as commercial, educational, and medical devices and wireless transmitters.** It also operates on the same frequency as licensed transmitters and special unlicensed low-voltage transmitters used in RFID tracking systems for assembly lines and in other similar applications.
- **To prevent interference with the above devices, observe the following precautions.** Confirm that the RFID transmitter is not in operation before using this device. Should you observe that the device causes interference in licensed transmitters used for RFID tracking, immediately stop using the affected frequency or move the device to another location. If you notice that this device causes interference in low-voltage RFID tracing systems, contact a Fujifilm representative.

- **Do not use this device on board an aircraft.** When on an aircraft, follow the instructions of airline personnel. Note that this product may emit radio-frequency radiation even when off. This can be prevented by selecting **ON** for **AIRPLANE MODE** in the network/USB setting menu before boarding.
- Requirements in AT/BG/BG/CZ/DK/EE/FR/DE/IS/IE/IT/EL/ES/CY/LV/LI/LT/LU/HU/MT/NL/NO/PL/PT/RO/SI/SK/TR/FI/SE/CH/UK/HR. 5150 MHz–5350 MHz is for indoor use only.

Specific Absorption Rate (SAR) Information

SAR is measured with the device at 0 mm to the body, while transmitting at the highest certified output power level in all frequency bands of the device. The maximum SAR value is 0.224 W/kg (head/body) averaged over 10 gram of tissue.

U.K. Importer:

FUJIFILM UK Limited

Fujifilm House, Whitbread Way, Bedford, Bedfordshire, MK42 0ZE, United Kingdom

EU Importer:

FUJIFILM Electronic Imaging Europe GmbH

Fujjistrasse 1 47533 Kleve, Germany

Be sure to read these notes before using the lens

Safety Notes

- Make sure that you use the lens correctly. Read these safety notes and the camera *Basic Manual* carefully before use.
- After reading these safety notes, store them in a safe place.

About the Icons

The icons shown below are used in this document to indicate the severity of the injury or damage that can result if the information indicated by the icon is ignored and the product is used incorrectly as a result.



WARNING

This icon indicates that death or serious injury can result if the information is ignored.



CAUTION

This icon indicates that personal injury or material damage can result if the information is ignored.

The icons shown below are used to indicate the nature of the instructions which are to be observed.



Triangular icons tell you that this information requires attention ("Important").



Circular icons with a diagonal bar tell you that the action indicated is prohibited ("Prohibited").



Filled circles with an exclamation mark indicate an action that must be performed ("Required").

! WARNING



Do not immerse

Do not immerse in or expose to water. Failure to observe this precaution can cause a fire or electric shock.



Do not disassemble

Do not disassemble (do not open the case). Failure to observe this precaution can cause fire, electric shock, or injury due to product malfunction.



Do not touch internal parts

Should the case break open as the result of a fall or other accident, do not touch the exposed parts. Failure to observe this precaution could result in electric shock or in injury from touching the damaged parts. Remove the battery immediately, taking care to avoid injury or electric shock, and take the product to the point of purchase for consultation.



Do not place on unstable surfaces. The product may fall, causing injury.



Do not view the sun through the lens or camera viewfinders. Failure to observe this precaution can cause permanent visual impairment.

! CAUTION



Do not use or store in locations that are exposed to steam, or smoke or are very humid or extremely dusty. Failure to observe this precaution can cause fire or electric shock.



Do not leave in direct sunlight or in locations subject to very high temperatures, such as in a closed vehicle on a sunny day. Failure to observe this precaution can cause fire.



Keep out of the reach of small children. This product could cause injury in the hands of a child.



Do not handle with wet hands. Failure to observe this precaution can cause electric shock.



Keep the sun out of the frame when shooting backlit subjects. Sunlight focused into the camera when the sun is in or close to the frame can cause fire or burns.



When the product is not in use, replace the lens caps and store out of direct sunlight. Sunlight focused by the lens can cause fire or burns.



Do not carry the camera or lens while they are attached to a tripod. The product can fall or strike other objects, causing injury.

Product Care

To ensure continued enjoyment of the product, observe the following precautions.

Camera body: Use a soft, dry cloth to clean the camera body after each use. Do not use alcohol, thinner, or other volatile chemicals, which could discolor or deform the leather on the camera body. Any liquid on the camera should be removed immediately with a soft, dry cloth. Use a blower to remove dust from the monitor, taking care to avoid scratches, and then gently wipe with a soft, dry cloth. Any remaining stains can be removed by wiping gently with a piece of Fujifilm lens-cleaning paper to which a small amount of lens-cleaning fluid has been applied. To prevent dust entering the camera, replace the body cap when no lens is in place.

Image sensor: Multiple photographs marred by spots or blotches in identical locations may indicate the presence of dust on the image sensor. Clean the sensor using  **USER SETTING > SENSOR CLEANING.**

Cleaning the Image Sensor

Dust that cannot be removed using **USER SETTING > SENSOR CLEANING** can be removed manually as described below.

! Note that there will be a charge to repair or replace the image sensor if it is damaged during cleaning.

- 1 Use a blower (not a brush) to remove dust from the sensor.

! Do not use a brush or blower brush. Failure to observe this precaution could damage the sensor.

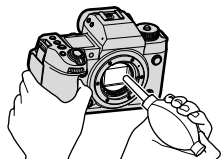

- 2 Check whether the dust has been successfully removed. Repeat Steps 1 and 2 as necessary.
- 3 Replace the body cap or lens.

Firmware Updates

Updates to product firmware may result in changes not described in the manual. For more information, visit: <https://fujifilm-x.com/support/download/firmware/cameras/>

Checking the Firmware Version

 The camera will only display the firmware version if a memory card is inserted.

- 1 Turn the camera off and check that a memory card is inserted.
- 2 Turn the camera on while pressing the **DISP/BACK** button. The current firmware version will be displayed; check the firmware version.
- 3 Turn the camera off.

 To view the firmware version or update firmware for optional accessories such as interchangeable lenses, shoe-mounted flash units, and mount adapters, mount the accessories on the camera.

Troubleshooting

Consult the table below should you encounter problems using your camera. If you don't find the solution here, contact your local Fujifilm distributor.



Troubleshooting information for network/USB features is available at:

https://fujifilm-dsc.com/en/manual/x-h2_connection/

Power and Battery

Problem	Solution
The camera does not turn on.	<ul style="list-style-type: none">• The battery was not charged before first use: The battery is not charged at shipment. Charge the battery before first use (📖 46).• The battery is exhausted: Charge the battery or insert a fully-charged spare battery (📖 46).• The battery is inserted incorrectly: Reinsert in the correct orientation (📖 40).• The battery-chamber cover is not latched: Latch the battery-chamber cover (📖 40).
The monitor does not turn on.	The monitor may not turn on if the camera is turned off and then on again very quickly. Keep the shutter button pressed halfway until the monitor activates.
The battery runs down quickly.	<ul style="list-style-type: none">• The battery is cold: Warm the battery by placing it in a pocket or other warm place and reinsert it in the camera immediately before taking a picture.• There is dirt on the battery terminals: Clean the terminals with a soft, dry cloth.• ON is selected for  AF/MF SETTING > PRE-AF: Turn PRE-AF off (📖 154).• The battery has been charged many times: Select BATTERY AGE to view the battery age; if the battery is old, replace it with a new battery (📖 250).
The camera turns off suddenly.	The battery is exhausted: Charge the battery or insert a fully-charged spare battery (📖 46).
The camera does not turn off.	The camera may be busy. Check the indicator lamp (📖 11).

Problem	Solution
Charging does not start.	<ul style="list-style-type: none"> • Make sure that the AC power adapter is correctly plugged in (📖 46). • Ensure that the plug adapter is correctly connected to the AC power adapter (📖 46). • The battery has not been recharged for an extended period: If the battery has not been charged for an extended period, charging will be disabled to ensure safety. Replace it with a new battery.
Charging does not start (USB).	<ul style="list-style-type: none"> • Insert the camera battery (📖 40). • Reinsert the camera battery in the correct orientation (📖 40). • Confirm that the camera is connected to the computer (📖 49). • If the computer is off or in sleep mode, turn on or wake the computer and disconnect and reconnect the USB cable (📖 49).
Charging does not start (battery charger).	<ul style="list-style-type: none"> • Insert the battery. • Reinsert the battery in the correct orientation. • The AC adapter is not correctly connected to the charger: Check that adapter is correctly connected to the charger.
Charging is slow.	Charge the battery at room temperature.
The indicator lamp blinks, but the battery does not charge.	<ul style="list-style-type: none"> • There is dirt on the battery terminals: Clean the terminals with a soft, dry cloth (📖 40). • The battery has been charged many times: Select BATTERY AGE to view the battery age; if the battery is old, replace it with a new battery (📖 250). If the battery still fails to charge, contact your Fujifilm dealer (📖 340).
The power supply icon is not displayed.	Confirm that POWER SUPPLY ON/COMM OFF is selected for USB POWER SUPPLY/COMM SETTING .

Menus and Displays

Problem	Solution
Display is not in English.	Select ENGLISH for USER SETTING > 言語/LANG. (📖 54, 249).

Shooting

Problem	Solution
No picture is taken when the shutter button is pressed.	<ul style="list-style-type: none">• The memory card is full: Insert a new memory card or delete pictures (📖 42, 225).• The memory card is not formatted: Format the memory card in the camera (📖 246).• There is dirt on the memory card contacts: Clean the contacts with a soft, dry cloth.• The memory card is damaged: Insert a new memory card (📖 42).• The battery is exhausted: Charge the battery or insert a fully-charged spare battery (📖 46).• The camera has turned off automatically: Turn the camera on (📖 50).• You are using a third-party mount adapter: Select ON for SHOOT WITHOUT LENS (📖 273).
Mottling (“noise”) appears in the monitor or viewfinder when the shutter button is pressed halfway.	Gain is increased to aid composition when the subject is poorly lit and aperture is stopped down, which may result in noticeable mottling when images are previewed in the displays. Images taken with the camera are unaffected.
The camera does not focus.	<ul style="list-style-type: none">• The subject is not suited to autofocus: Use focus lock or manual focus (📖 109).• The focus area is too small for the intended subject: Increase the size of the focus area by a couple of steps (📖 98).
No panorama is recorded when the shutter button is pressed.	The indicator lamp was orange when you attempted to record a panorama: Wait until the indicator lamps turns off (📖 11).

Problem	Solution
No face is detected.	<ul style="list-style-type: none"> • The subject's face is obscured by sunglasses, a hat, long hair, or other objects: Remove the obstructions (📖 155). • The subject's face occupies only a small area of the frame: Change the composition so that the subject's face occupies a larger area of the frame (📖 155). • The subject's face is turned away from the camera: Ask the subject to face the camera (📖 155). • 👤 FACE/EYE DETECTION SETTING is off: Turn 👤 FACE/EYE DETECTION SETTING on (📖 155). • The camera is tilted: Keep the camera level. • The subject's face is poorly lit: Shoot in better light.
No subject is detected.	<ul style="list-style-type: none"> • The subject is partially hidden: Choose a vantage point where you can see as much of the subject as possible (📖 157). • The subject occupies only a small portion of the frame: Get closer to your subject so it occupies more of the frame (📖 157). • OFF is selected for SUBJECT DETECTION SETTING: Select SUBJECT DETECTION ON (📖 157). • The subject is poorly lit: Shoot in better light.
The flash does not fire.	<ul style="list-style-type: none"> • The flash is disabled: Adjust settings (📖 177). • The electronic shutter is enabled: Choose a SHUTTERTYPE that does not use the electronic shutter (📖 173). • The battery is exhausted: Charge the battery or insert a fully-charged spare battery (📖 46). • The camera is in bracketing or continuous mode: Select single frame mode (📖 9).
The flash does not fully light the subject.	<ul style="list-style-type: none"> • The subject is not in range of the flash: Position the subject in range of the flash. • The flash window is obstructed: Hold the camera correctly. • Shutter speed is faster than the sync speed: Choose a slower shutter speed (📖 74, 78, 375).

Problem	Solution
Pictures are blurred.	<ul style="list-style-type: none"> • The lens is dirty: Clean the lens. • The lens is blocked: Keep objects away from the lens (📖 57). • !AF is displayed during shooting and the focus frame is displayed in red: Check focus before shooting (📖 58).
Pictures are mottled.	<ul style="list-style-type: none"> • Shutter speed is slow and the ambient temperature is high: This is normal and does not indicate a malfunction.* Use pixel mapping (📖 143). * X-rays, cosmic rays, and other forms of radiation interacting with the image sensor may cause bright spots of various colors such as white, red, and blue. Pixel mapping helps reduce the occurrence of such bright spots. • The camera has been used continuously at high temperatures: Turn the camera off and wait for it to cool down (📖 50, 370). • A temperature warning is displayed: Turn the camera off and wait for it to cool down (📖 50, 370).

Playback

Problem	Solution
Pictures are grainy.	The pictures were taken with a different make or model of camera.
Playback zoom is unavailable.	The pictures were created using RESIZE or with a different make or model of camera.
No sound in movie playback.	<ul style="list-style-type: none"> • Playback volume is too low: Adjust playback volume (🗨️ 254). • The microphone was obstructed: Hold the camera correctly during recording. • The speaker is obstructed: Hold the camera correctly during playback.
Selected pictures are not deleted.	Some of the pictures selected for deletion are protected.
Pictures remain after ERASE > ALL FRAMES is selected.	Remove protection using the device with which it was originally applied (🗨️ 229).
File numbering is unexpectedly reset.	The battery-chamber cover was opened while the camera was on. Turn the camera off before opening the battery-chamber cover (🗨️ 283).

Connections



Problem	Solution
The monitor is blank.	The camera is connected to a TV: Pictures will be displayed on the TV instead of in the camera monitor (📖 60).
Both the TV and camera monitor are blank.	The display mode selected with the VIEW MODE button is EVF ONLY +  : Put your eye to the viewfinder. Use the VIEW MODE button to choose another display mode (📖 18).
No picture or sound on TV.	<ul style="list-style-type: none"> • The camera is not properly connected: Connect the camera properly (📖 60). • Input on the television is set to “TV”: Set input to “HDMI” (📖 60). • The volume on the TV is too low: Use the controls on the television to adjust the volume (📖 60).

Miscellaneous





Problem	Solution
The camera is unresponsive.	<ul style="list-style-type: none"> • Temporary camera malfunction: Remove and reinsert the battery (📖 40). • The battery is exhausted: Charge the battery or insert a fully-charged spare battery (📖 46). • The camera is connected to a wireless LAN: End the connection. • The controls are locked: Press and hold the MENU/OK button to unlock the controls (📖 15, 17).
The camera does not function as expected.	Remove and reinsert the battery (📖 40). If the problem persists, contact your Fujifilm dealer.
No sound.	Adjust the volume (📖 252).
Pressing the Q button does not display the quick menu.	TTL-LOCK is active: End TTL-LOCK (📖 178).



Warning Messages and Displays

The following warnings appear in the display.

Warning	Description
 (red)	Low battery. Charge the battery or insert a fully-charged spare battery.
 (blinks red)	Battery exhausted. Charge the battery or insert a fully-charged spare battery.
!AF (displayed in red with red focus frame)	The camera cannot focus. Use focus lock to focus on another subject at the same distance, then recompose the picture.
Aperture or shutter speed displayed in red	The subject is too bright or too dark and the picture will be over- or under-exposed. Use the flash for additional lighting when taking photographs of poorly-lit subject.
FOCUS ERROR	Camera malfunction. Turn the camera off, remove the lens, and check for foreign matter between the lens and the camera body, then replace the lens and turn the camera on. If the problem persists, contact a Fujifilm dealer.
LENS CONTROL ERROR	
TURN OFF THE CAMERA AND TURN ON AGAIN	
CARD NOT INITIALIZED	<ul style="list-style-type: none">• The memory card is not formatted or the memory card has been formatted in a computer or other device: Format the memory card using  USER SETTING > FORMAT.• The memory card contacts require cleaning: Clean the contacts with a soft, dry cloth. If the message is repeated, format the card. If the message persists, replace the card.• Camera malfunction: Contact a Fujifilm dealer.
LENS ERROR	Turn the camera off, remove the lens, and check for foreign matter between the lens and the camera body, then replace the lens and turn the camera on. If the problem persists, contact a Fujifilm dealer.

Warning	Description
CARD ERROR	<ul style="list-style-type: none"> • The memory card is not formatted for use in the camera: Format the card. • The memory card contacts require cleaning or the memory card is damaged: Clean the contacts with a soft, dry cloth. If the message is repeated, format the card. If the message persists, replace the card. • Incompatible memory card: Use a compatible card. • Camera malfunction: Contact a Fujifilm dealer.
PROTECTED CARD	The memory card is locked. Unlock the card.
BUSY	The memory card is incorrectly formatted. Use the camera to format the card.
SD MEMORY FULL	The memory card is full and pictures cannot be recorded. Delete pictures or insert a memory card with more free space.
WRITE ERROR	<ul style="list-style-type: none"> • Memory card error or connection error: Reinsert the card or turn the camera off and then on again. If the message persists, contact a Fujifilm dealer. • Not enough memory remaining to record additional pictures: Delete pictures or insert a memory card with more free space. • The memory card is not formatted: Format the memory card. • The memory card was removed while data were being recorded: Do not remove the memory card during recording. • The memory card write speed is slow: When recording movies, be sure the memory card write speed is fast enough.
FRAME NO. FULL	The camera has run out of frame numbers (current frame number is 999-9999). Insert a formatted memory card and select RENEW for SAVE DATA SET-UP > FRAME NO. Take a picture to reset frame numbering to 100-0001, then select CONTINUOUS for FRAME NO.

Warning	Description
READ ERROR	<ul style="list-style-type: none"> • The file is corrupt or was not created with the camera: The file cannot be viewed. • The memory card contacts require cleaning: Clean the contacts with a soft, dry cloth. If the message is repeated, format the card. If the message persists, replace the card. • Camera malfunction: Contact a Fujifilm dealer.
PROTECTED FRAME	An attempt was made to delete or rotate to a protected picture. Remove protection and try again.
CAN NOT CROP	The picture is damaged or was not created with the camera.
DPOF FILE ERROR	Print orders can contain no more than 999 pictures. Copy any additional pictures you wish to print to another memory card and create a second print order.
CAN NOT SET DPOF	The picture cannot be printed using DPOF.
 CAN NOT SET DPOF	Movies cannot be printed using DPOF.
CAN NOT ROTATE	The selected picture cannot be rotated.
 CAN NOT ROTATE	Movies cannot be rotated.
 CANNOT EXECUTE	The selected operation is not supported: Check whether the picture was recorded with a different model of camera.
 CANNOT EXECUTE	

Warning	Description
 (yellow) CAMERA IS APPROACHING STANDARD TEMPERATURE LIMIT	The camera is approaching the maximum temperature allowed when STANDARD is selected for AUTO POWER OFF TEMP. and will shortly turn off automatically. Turn the camera off and wait for it to cool.
 (yellow) CAMERA IS APPROACHING HIGH TEMPERATURE LIMIT.DO NOT HOLD CAMERA FOR LONG PERIODS OF TIME	The camera is approaching the maximum temperature allowed when HIGH is selected for AUTO POWER OFF TEMP. and will shortly turn off automatically. Remaining in contact with the camera could result in low-temperature burns; mount the camera on a tripod or take other steps to avoid prolonged contact with the camera. The camera will shortly turn off automatically. Turn the camera off and wait for it to cool. Mottling may increase in pictures taken when this warning is displayed.
 (red) HIGH TEMPERATURE LIMIT REACHED SHUTTING DOWN	The camera temperature has reached the cutoff point and the camera is about to turn off automatically. Turn the camera off and wait for it to cool. Mottling may increase in pictures taken when this warning is displayed.

Memory Card Capacity

The following table shows the recording time or number of pictures available at different image sizes. All figures are approximate; file size varies with the scene recorded, producing wide variations in the number of files that can be stored. The number of exposures or length remaining may not diminish at an even rate.

Capacity		SD/CFexpress memory cards 64 GB	
		FINE	NORMAL
Photos	3:2	2660	3980
	RAW (UNCOMPRESSED)	730	
	RAW (LOSSLESS COMPRESSED)	1380	
	RAW (COMPRESSED)	1950	
Movies ^{1,2}	4K 2160	79 minutes	
	FHD 1080	79 minutes	

1 Use a UHS speed class 3 card or better.

2 Assumes default bit rate.

Shots over an hour in length may be recorded across multiple files without interruption. In addition, movies over 4 GB in size will be recorded uninterrupted across multiple files to SD memory cards with capacities 32 GB or less.

Specifications

System	
Model	FUJIFILM X-H2
Product Number	FF210003
Effective pixels	Approx. 40.2 million
Image sensor	23.5 mm × 15.7 mm (APS-C), X-Trans CMOS 5 HR sensor with primary color filter
Storage media	Fujifilm-recommended SD/SDHC/SDXC and CFexpress Type B memory cards
Memory card slots	<ul style="list-style-type: none">• SD memory card slot (UHS-II compliant) ×1• CFexpress memory card slot (Type B) ×1
File system	<ul style="list-style-type: none">• Still pictures: Compliant with DCF 2.0• Compressed: Exif 2.32 JPEG-baseline compliant; DPOF compliant; HEIF compliant (4:2:2, 10-bit)• Uncompressed or compressed using a reversible or non-reversible algorithm: RAW (original RAF format; special-purpose software required); RAW+JPEG available; TIFF (RGB)• Movies: Compliant with HEVC/H.265, H.264, and ProRes• Audio (including voice memos):<ul style="list-style-type: none">- LPCM (two channels: 24-bit, 48 kHz sampling)- AAC (MP4 recordings only)• Audio (via XLR microphone adapter):<ul style="list-style-type: none">- LPCM (two channels: 24-bit, 48 kHz sampling; four channels: 24-bit, 48 kHz sampling)- AAC (MP4 recordings only; two channels: 16-bit, 48 kHz sampling)

System

Image size	L 3:2 (7728 × 5152)	L 4:3 (6864 × 5152)
	L 16:9 (7728 × 4344)	L 5:4 (6432 × 5152)
	L 1:1 (5152 × 5152)	
	M 3:2 (5472 × 3648)	M 4:3 (4864 × 3648)
	M 16:9 (5472 × 3080)	M 5:4 (4560 × 3648)
	M 1:1 (3648 × 3648)	
	S 3:2 (3888 × 2592)	S 4:3 (3456 × 2592)
	S 16:9 (3888 × 2184)	S 5:4 (3264 × 2592)
	S 1:1 (2592 × 2592)	
	RAW (7872 × 5196)	TIFF (7728 × 5152)
	L panorama: vertical (2160 × 9600)/horizontal (9600 × 1440)	
	M panorama: vertical (2160 × 6400)/horizontal (6400 × 1440)	
Lens mount	FUJIFILM X mount	
Sensitivity	<ul style="list-style-type: none"> • Still pictures: Standard output sensitivity equivalent to ISO 125–12800 in increments of 1/3 EV; AUTO 1–3; extended output sensitivity equivalent to ISO 64, 80, 100, 25600, or 51200 • Movies: Standard output sensitivity equivalent to ISO 125–12800 in increments of 1/3 EV; AUTO; extended output sensitivity equivalent to ISO 25600 	
Metering	256-segment through-the-lens (TTL) metering; MULTI, SPOT, AVERAGE, CENTER WEIGHTED	
Exposure control	Programmed AE (with program shift); shutter-priority AE; aperture-priority AE; manual exposure	
Exposure compensation	<ul style="list-style-type: none"> • Still pictures: –5 EV–+5 EV in increments of 1/3 EV • Movies: –2 EV–+2 EV in increments of 1/3 EV 	

System

Shutter speed

- **MECHANICAL SHUTTER, E-FRONT CURTAIN SHUTTER, E-FRONT + MECHANICAL**
 - **Mode P:** 4 s to $\frac{1}{8000}$ s
 - **Mode A:** 30 s to $\frac{1}{8000}$ s
 - **Modes S and M:** 15 min. to $\frac{1}{8000}$ s
 - **Bulb:** Max. 60 min.
- **ELECTRONIC SHUTTER**
 - **Mode P:** 4 s to $\frac{1}{180000}$ s
 - **Mode A:** 30 s to $\frac{1}{180000}$ s
 - **Modes S and M:** 15 min. to $\frac{1}{180000}$ s
 - **Bulb:** Fixed at 1 s
- **MECHANICAL + ELECTRONIC, E-FRONT + MECHANICAL + ELECTRONIC**
 - **Mode P:** 4 s to $\frac{1}{180000}$ s
 - **Mode A:** 30 s to $\frac{1}{180000}$ s
 - **Modes S and M:** 15 min. to $\frac{1}{180000}$ s
 - **Bulb:** Max. 60 min.

Continuous

CONTINUOUS MODE	Available frame advance rates (JPEG)
20fps(1.29X CROP)¹	20
13fps(1.29X CROP)¹	13
10fps(1.29X CROP)¹	10
15fps²	15
10fps³	10
7.0fps⁴	7.0
5.0fps	5.0
3.0fps	3.0

¹ Available with electronic shutter only.

² 13 fps with electronic shutter.

³ 38.9 fps with electronic shutter.

⁴ 46.7 fps with electronic shutter.

 The frame rate and number of frames per burst varies with shooting conditions and type of memory card used.

System	
Focus	<ul style="list-style-type: none"> • Mode: Single or continuous AF; manual focus with focus ring • Autofocus system: Intelligent hybrid AF (TTL contrast-detect/phase-detection AF) • Focus-area selection: SINGLE POINT, ZONE, WIDE/TRACKING, ALL
White balance	Auto (WHITE PRIORITY, AUTO, AMBIENCE PRIORITY), Custom 1, Custom 2, Custom 3, color temperature selection, direct sunlight, shade, daylight fluorescent, warm white fluorescent, cool white fluorescent, incandescent, underwater
Self-timer	Off, 2 sec., 10 sec.
Flash mode	<ul style="list-style-type: none"> • MODE: TTL MODE (FLASH AUTO, STANDARD, SLOW SYNC.), MANUAL, MULTI, OFF • SYNC. MODE: 1ST CURTAIN, 2ND CURTAIN, AUTO FP (high-speed sync) • RED EYE REMOVAL:  FLASH, OFF
Hot shoe	Provided (supports TTL flash control); supports sync speeds as fast as $\frac{1}{250}$ s
Sync contact	X contact; supports sync speeds as fast as $\frac{1}{250}$ s
Sync terminal	Provided
Electronic viewfinder (EVF)	0.5-in., 5760k-dot OLED viewfinder; magnification 0.80 \times with 50 mm lens (35 mm format equivalent) at infinity and diopter set to -1.0 m $^{-1}$; diagonal angle of view approximately 40 $^{\circ}$ (horizontal angle of view approximately 32 $^{\circ}$) <ul style="list-style-type: none"> • Diopter adjustment: -5 to $+3$ m$^{-1}$ • Eyepoint: Approximately 24 mm
LCD monitor	<ul style="list-style-type: none"> • Rear monitor: 3.0-in/7.6 cm, 1620k-dot color touch screen LCD monitor, Vari-angle LCD monitor • Shoulder monitor: 1.28-in/3.25 cm, 128 \times 128-dot memory LCD monitor

System

- Movies**
(with stereo sound)
- **Movie size:** **8K** 16:9, **6.2K** 16:9, **4K** 16:9, **DCI** 17:9, **4K** 16:9, **DCI** 17:9, **FHD** 16:9, **FHD** 17:9
 - **Frame rate:** 59.94P, 50P, 29.97P, 25P, 24P, 23.98P
 - **Recording/output format:**
 - H.265 (10-bit MOV 4:2:2/4:2:0; 720, 360, 200, 100, or 50 Mbps)
 - H.264 (8-bit MOV/MP4 4:2:0; 360, 200, 100, or 50Mbps)
 - ProRes 422 HQ, ProRes 422, ProRes 422 LT (10-bit MOV 4:2:2)
 - HDMI output supported (RAW output supported with Atomos and Blackmagic Design external recorders; 8-bit 4:2:2/10-bit 4:2:2)
-
- High-speed movies**
- **Movie size:** **FHD** 16:9, **FHD** 17:9
 - **Frame advance rate:** 240P, 200P, 120P, 100P

Input/output terminals

Microphone connector	ø3.5 mm mini-stereo jack
Headphone jack socket	ø3.5 mm mini-stereo jack
Remote release connector	ø2.5 mm 3-pole mini jack
Digital input/output	USB connector (Type-C) USB3.2 Gen2x1
HDMI output	HDMI connector (Type A)

Power supply/other

Power supply NP-W235 rechargeable battery (supplied with camera)

Battery life

- **Battery type:** NP-W235
- **Lens:** XF35mmF1.4 R
- **External flash units:** Disabled
- **Shooting mode:** Mode P

Number of shots		
PERFORMANCE	LCD	EVF
BOOST¹	Approx. 530	Approx. 400
NORMAL	Approx. 540	Approx. 510
ECONOMY	Approx. 680	Approx. 570

Number of shots (VG-XH vertical battery grip)		
PERFORMANCE	LCD	EVF
BOOST¹	Approx. 1420	Approx. 1080
NORMAL	Approx. 1430	Approx. 1350
ECONOMY	Approx. 1760	Approx. 1490

Total length of footage that can be recorded on a single charge		
Mode	Actual battery life of movie capture	Continuance battery life of movie capture
8K²	Approx. 70 minutes	Approx. 100 minutes
6.2K²	Approx. 75 minutes	Approx. 105 minutes
4K³	Approx. 75 minutes	Approx. 120 minutes
FHD³	Approx. 85 minutes	Approx. 140 minutes
High-speed movies⁴	Approx. 90 minutes	—

1 **EVF FRAME RATE PRIORITY (120P)** selected **EVF/LCD BOOST SETTING**.

2 At a frame rate of 29.97 fps.

3 At a frame rate of 59.94 fps.

4 At a frame rate of 120 fps.

CIPA standard. Measured using battery supplied with camera and SD memory card.

Note: Battery endurance varies with battery charge level and the figures given above are not guaranteed. Battery endurance will decline at low temperatures.

Power supply/other

Camera size (W × H × D) 136.3 mm × 92.9 mm × 84.6 mm (42.8 mm excluding projections, measured at thinnest part)/5.37 in. × 3.66 in. × 3.33 in. (1.69 in.)

Camera weight Approx. 579 g/20.5 oz., excluding battery, accessories, and memory card

Shooting weight Approx. 660 g/23.3 oz., including battery and memory card

Operating conditions

- **Temperature:** -10 °C to +40 °C/+14 °F to +104 °F (+5 °C to +40 °C/+41 °F to +104 °F when battery is charging)
- **Humidity:** 10% to 80% (no condensation)

Wireless transmitter

Wireless LAN

Standards IEEE 802.11a/b/g/n/ac (standard wireless protocol)

Operating frequency (center frequency)

- **Israel, Indonesia**
: 2,412 MHz–2,462 MHz (11 channels)
- **USA, Canada, Brazil, China, India, Korea, Malaysia**
: 2,412 MHz–2,462 MHz (11 channels)
: 5,180 MHz–5,320 MHz (W52, W53)
: 5,745 MHz–5,825 MHz (UNII-3)
- **European Union, Japan, United Kingdom, Australia, Norway, New Zealand, Turkey, Hong Kong, Philippines, Vietnam, Singapore, Thailand, UAE, Russia, Taiwan, Saudi Arabia, Qatar, Bahrain, Oman, Egypt, Iran, Kuwait, Lebanon, Uzbekistan**
: 2,412 MHz–2,462 MHz (11 channels)
: 5,180 MHz–5,320 MHz (W52, W53)
: 5,500 MHz–5,700 MHz (W56)

Access protocols Infrastructure

Bluetooth®

Standards Bluetooth version 4.2 (Bluetooth Low Energy)

Operating frequency (center frequency) 2,402 MHz–2,480 MHz

NP-W235 rechargeable battery

Nominal voltage	7.2 V
Nominal capacity	2350 mAh
Rating capacity	2200 mAh
Operating temperature	0 °C to +40 °C/+32 °F to +104 °F
Dimensions (W × H × D)	38.92 mm × 22.8 mm × 52.26 mm/ 1.5 in. × 0.9 in. × 2.1 in.
Weight	Approx. 79 g/2.8 oz.

AC-5VJ AC power adapter

Manufacturer	Dongguan Yingjiu Power Co.,Ltd.
Address	No.6 Yongxing Road, Shayao Village, Shijie Town, 523292 Dongguan City, Guangdong Province, PEOPLE'S REPUBLIC OF CHINA
Model name	AC-5VJ
Rated input	100 V – 240 V AC, 50/60 Hz
Input capacity	Max. 50 VA
Rated output	DC5.0V 3.0A 15.0W
Average active efficiency	84.8 %
Efficiency at load 10%	84.2 %
No-load power consumption	0.02 W
Operating temperature	0 °C to +40 °C/+32 °F to +104 °F
Weight	Approx. 45 g ± 2 g/1.6 oz. ± 0.1 oz.

 Weight and dimensions vary with the country or region of sale.

 Specifications and performance are subject to change without notice. Fujifilm will not be held liable for any errors this manual may contain. The appearance of the product may differ from that described in this manual.

FUJIFILM

FUJIFILM Corporation

7-3, AKASAKA 9-CHOME, MINATO-KU, TOKYO 107-0052, JAPAN

<https://fujifilm-x.com>

